



OUTDOOR CLASSROOM SOLUTIONS

Agile classrooms and spaces that flex and adapt to meet changing needs

Classrooms with a growth mindset can expand education beyond four walls. Placemaking in existing, usable outdoor space is an opportunity to create an open-air classroom concept without reducing student enrollment due to social distancing efforts and limited indoor space.

- ✓ Encourages safe group-based collaborative learning
- ✓ Socially distanced table floorplan
- ✓ Protective tabletop sneeze guards
- ✓ Stimulates social and emotional learning
- ✓ Versatile usability for learning, dining, assemblies, playing, and more
- ✓ Optional lighting, audio, video, and other electrical integrations
- ✓ ADA accessible seating areas and pathways
- ✓ Quality shade structures designed for UV, heat, and weather protection

We support health and safety changes for schools wanting to protect students, faculty, and staff from the spread of illnesses.

Call Pelican Playgrounds to start your outdoor growth initiative today.



USASHADE 504-909-6544
& Fabric Structures www.pelicanplaygrounds.com



Resilient and Flexible Design Responses to Expand Learning Spaces

Hip



30'x30' or 40'x40'

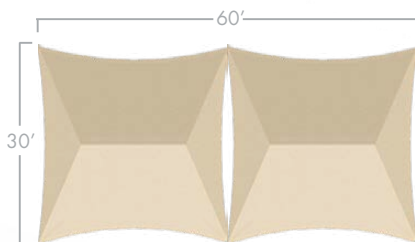

30'x60'
(30'x30' joined)

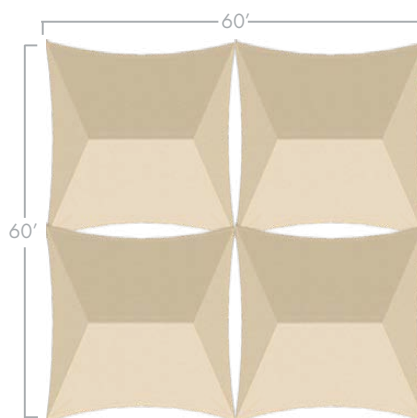

60'x60'
(30'x30' quadrant)

Mariner



30'x30' or 40'x40'

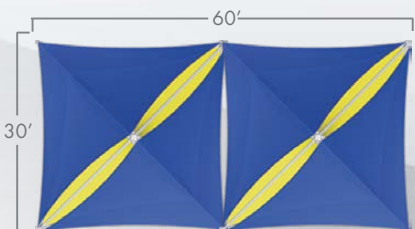

30'x60'
(30'x30' joined)

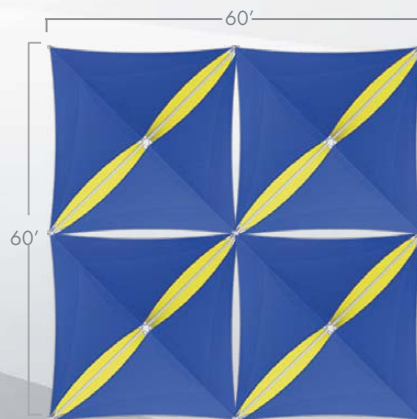

60'x60'
(30'x30' quadrant)



Benefits



Up to 25°F
temperature
reduction



Block up to
97% of harmful
UV rays



Safeguards against
sun and weather
damage



10-year
warranty

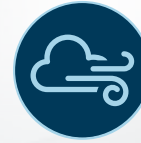

Increase airflow
and comfort



Low
maintenance

Shade Fabric Colors

Shadesure™ fabrics carry a comprehensive manufacturer's warranty from the date of installation against failure from significant fading, deterioration, breakdown outdoor heat, cold, or discoloration. All of our fabrics are easy to maintain, providing protective shade and vibrant color over a long life.

Color Options



WHITE SHADE 57% UV 86%	SILVER SHADE 88% UV 93%	LAGUNA BLUE SHADE 92% UV 96%	ROYAL BLUE SHADE 86% UV 94%	NAVY BLUE SHADE 90% UV 94%	TURQUOISE SHADE 83% UV 92%	RAINFORREST SHADE 89% UV 96%	DESERT SAND SHADE 80% UV 92%	BLACK SHADE 95% UV 96%
-------------------------------------	--------------------------------------	---	--	---	---	---	---	-------------------------------------



SUNFLOWER YELLOW SHADE 70% UV 94%	TERRACOTTA SHADE 84% UV 90%	ARIZONA SHADE 86% UV 91%	ATOMIC ORANGE SHADE 82% UV 94%	RED SHADE 91% UV 92%	MULBERRY SHADE 90% UV 91%	ELECTRIC PURPLE SHADE 84% UV 90%	ZESTY LIME SHADE 83% UV 92%	CINNAMON SHADE 88% UV 93%
--	--	---------------------------------------	---	-----------------------------------	--	---	--	--



OLIVE SHADE 93% UV 97%	CHOCOLATE SHADE 92% UV 93%
-------------------------------------	---



Economical and Scalable Seating

Gathering tables are the perfect seating solution to optimize school outdoor spaces.

Each table style has in-ground, portable, or surface-mount mounting options and comes in a variety of plastisol or powder coat colors.

Removeable tabletop divider systems can be added to enhance collaborative learning environments and social engagement while protecting against the spread of germs between students in close proximity.

Camden 42" Round

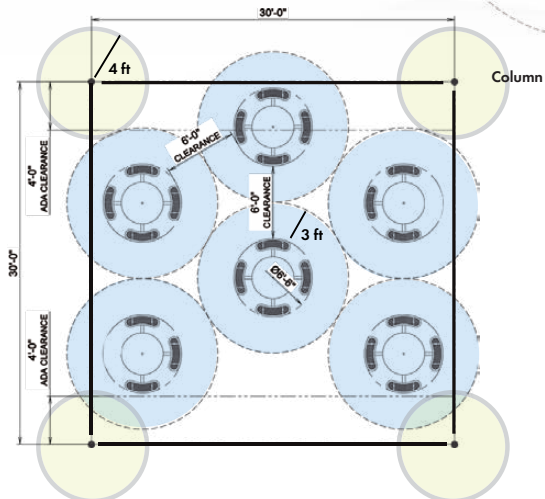
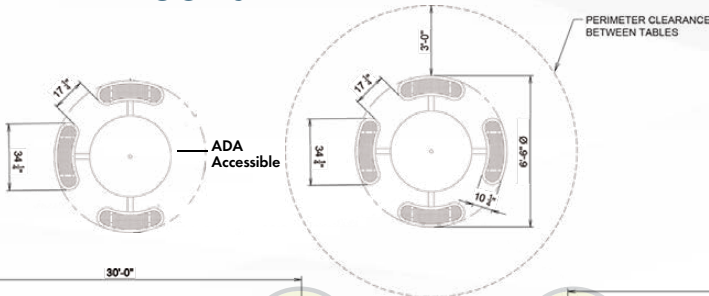

30'x30' Structure - Seats up to 24

(Minimum of 2 ADA Accessible seating areas)

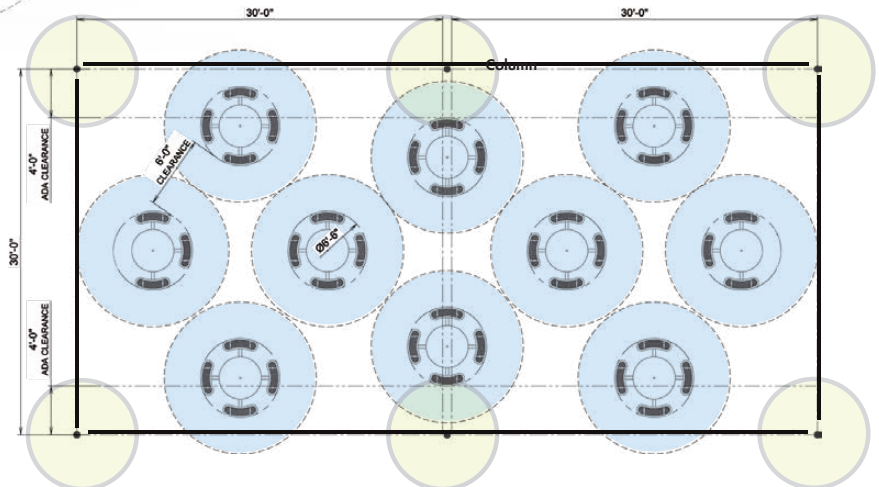

30'x60' Structure - Seats up to 40

(Minimum of 2 ADA Accessible seating areas)

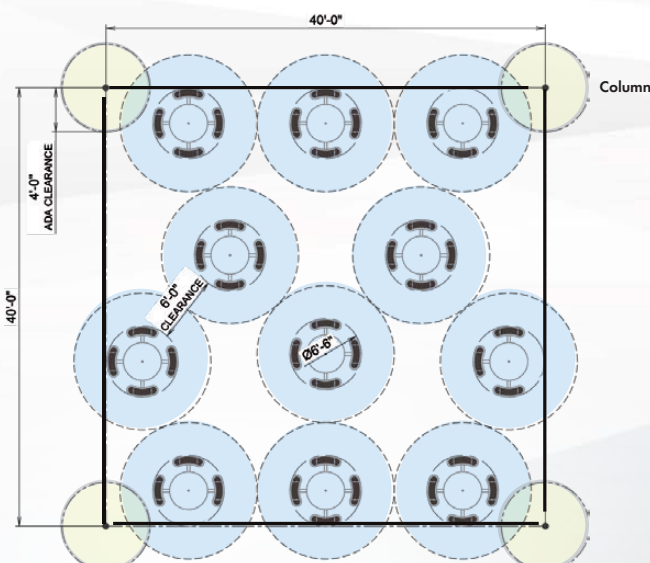

40'x40' Structure - Seats up to 44

(Minimum of 3 ADA Accessible seating areas)

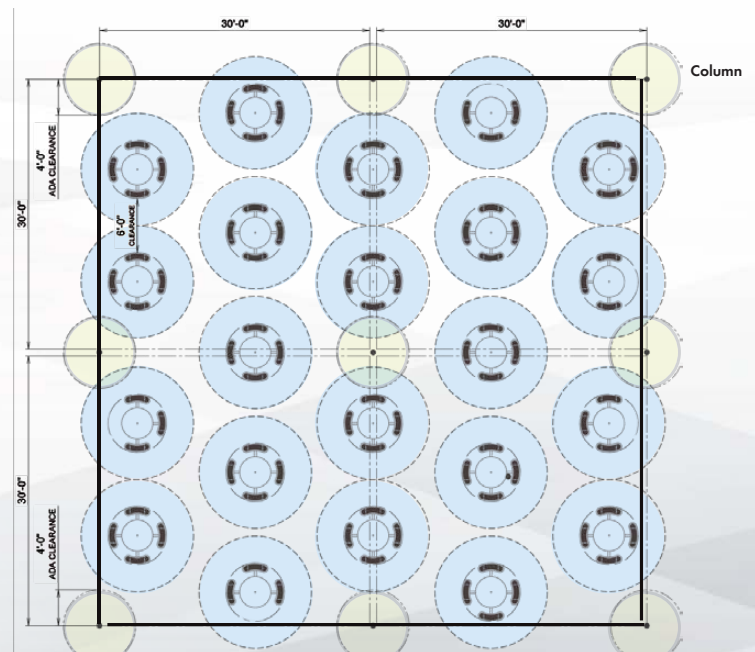

60'x60' Structure - Seats up to 88

(Minimum of 5 ADA Accessible seating areas)

Camden 7' Rectangular

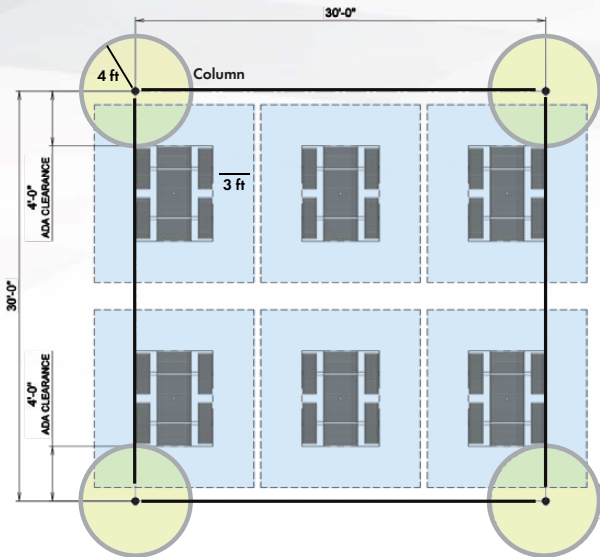
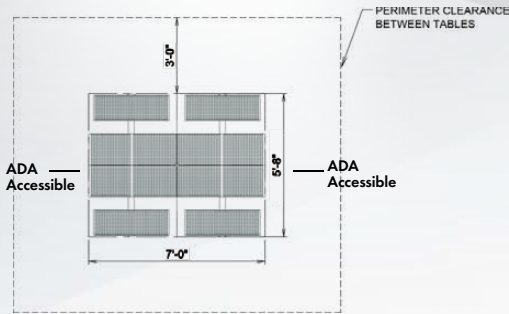

30'x30' Structure - Seats up to 24
(Maximum of 12 ADA Accessible seating areas)

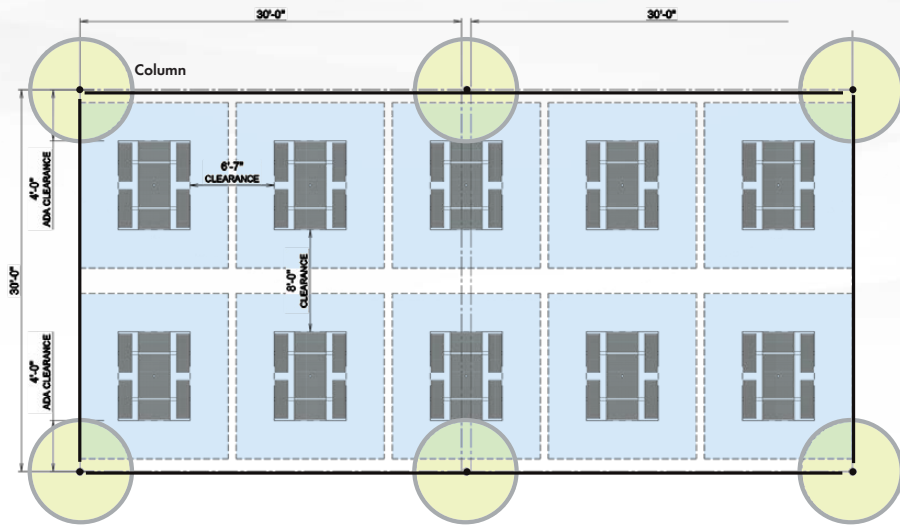

30'x60' Structure - Seats up to 40
(Maximum of 20 ADA Accessible seating areas)

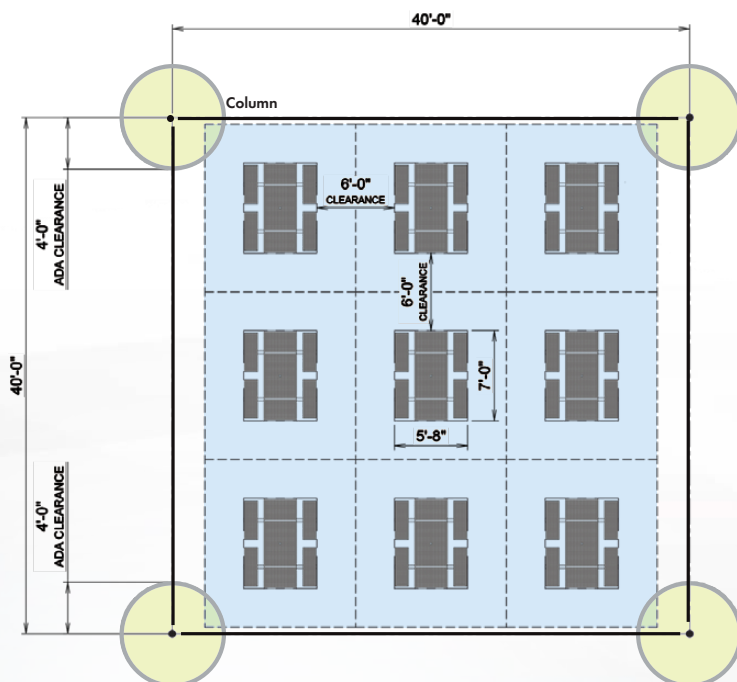

40'x40' Structure - Seats up to 36
(Maximum of 18 ADA Accessible seating areas)

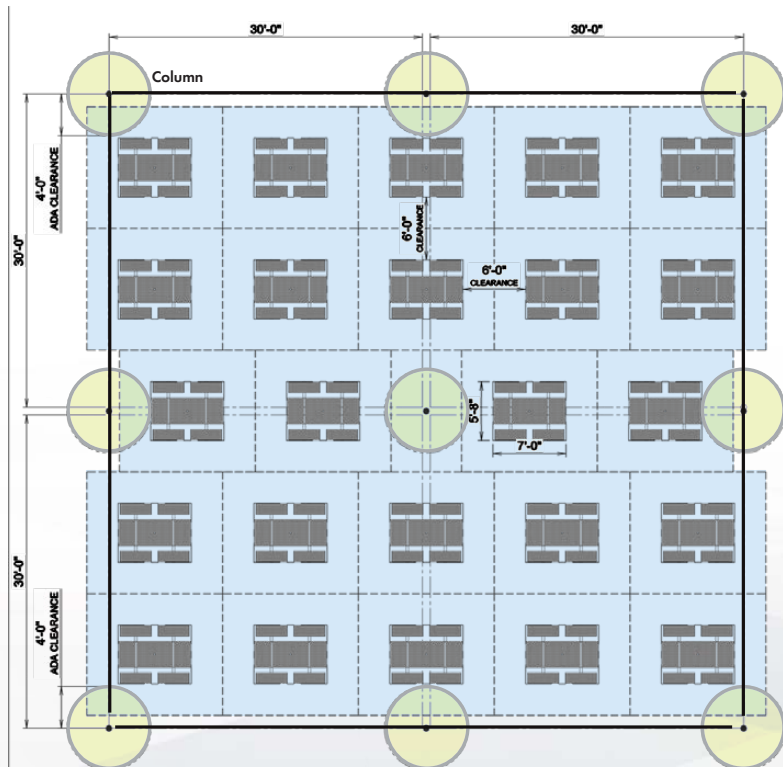

60'x60' Structure - Seats up to 96
(Maximum of 48 ADA Accessible seating areas)

Spyder 11' Rectangular

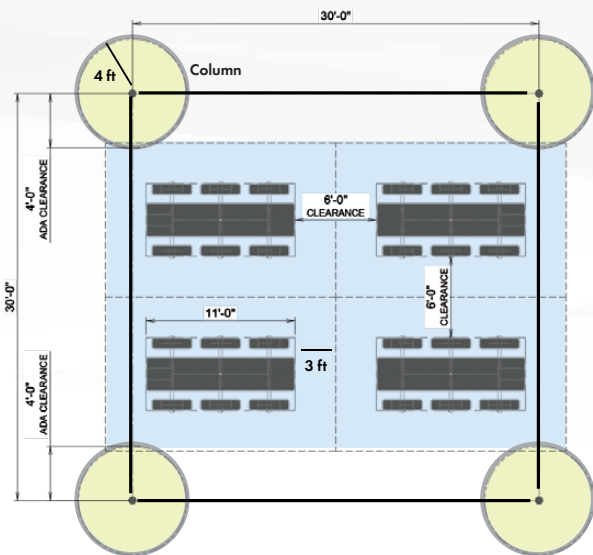
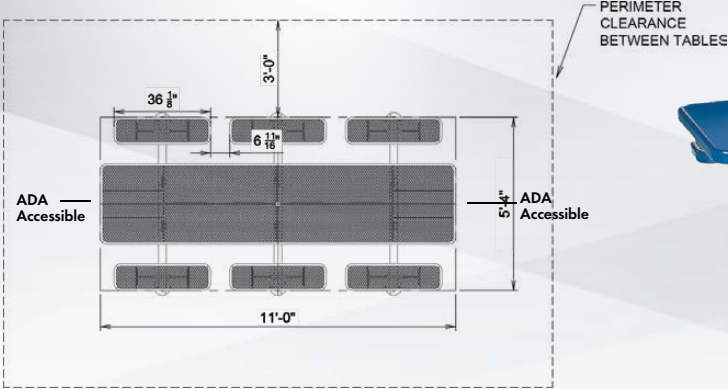

30'x30' Structure - Seats up to 24
(Maximum of 8 ADA Accessible seating areas)

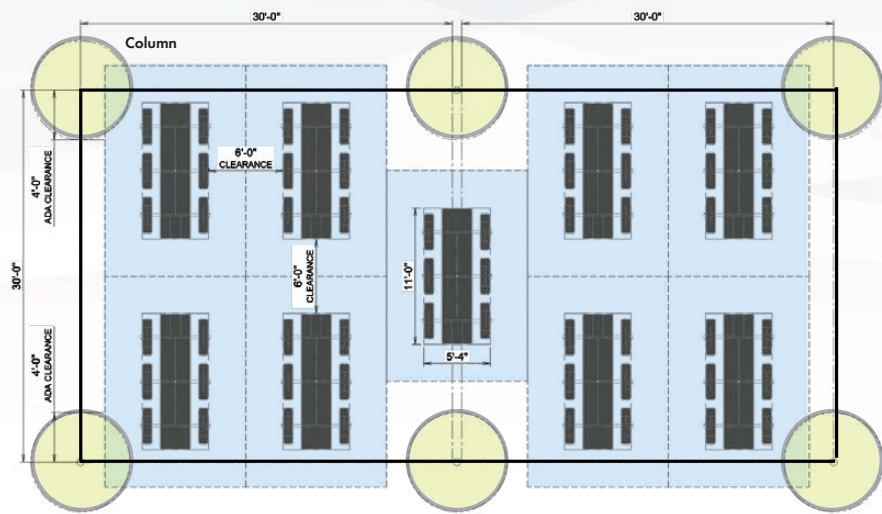

30'x60' Structure - Seats up to 54
(Maximum of 18 ADA Accessible seating areas)

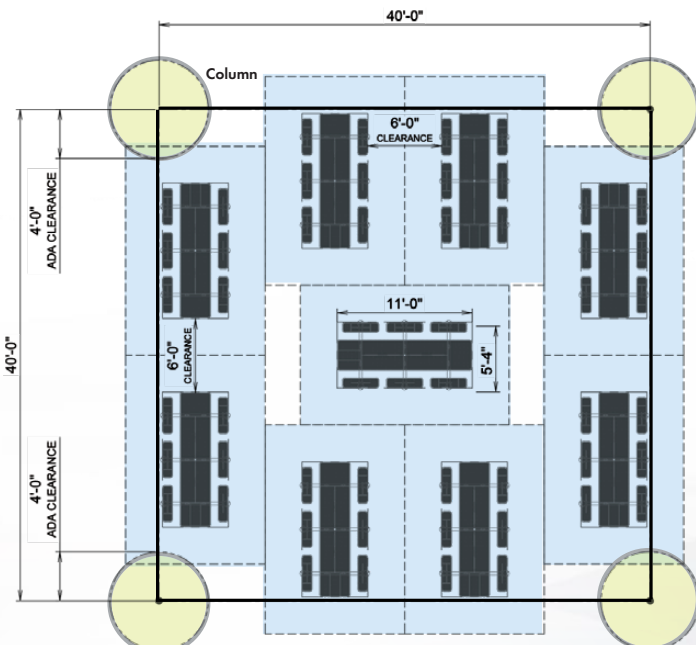

40'x40' Structure - Seats up to 54
(Maximum of 18 ADA Accessible seating areas)

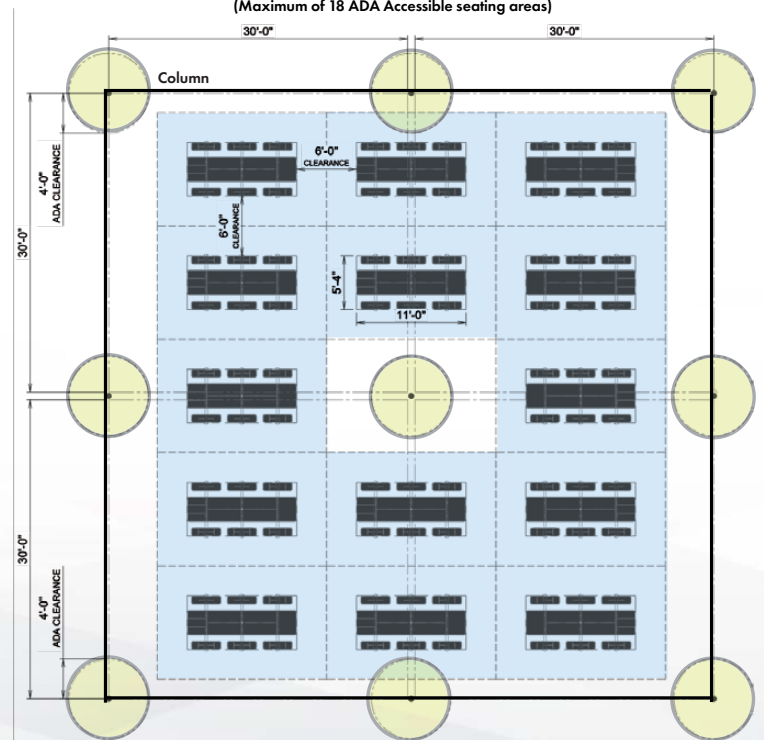

60'x60' Structure - Seats up to 84
(Maximum of 24 ADA Accessible seating areas)