

ALWAYS there for you

Table of Contents

Always There - What, How, and Why	4
Heritage Collection Overview	6
Urbanscape Collection Overview	7
Heritage Collection	8
Camino	10
Contemporary	12
Courtyard	14
Estate	16
Rinnova	18
Signature	20
Spyder	26
Transit	28
Urbanscape Collection	30
Butler	32
Covington	34
Fairmount	36
Green Valley	40
Hanna	44
Liberty	46
Oxford	52
Sullivan	54
Woodridge	56
Yorktown	58
Bike Racks	60
Grills & Fire Rings	61
HAGS Collection	62
Ekeby	64
Picnic Tables	66
Benches	68
Bike Racks	70
Trash Receptacles	72
Umbrellas	74
Order Information	78



A photograph of an outdoor dining area. In the foreground, several white metal chairs with a grid-like backrest are arranged around a table covered with a white tablecloth. The table is set on a brick-paved patio. In the background, there are large glass windows reflecting the street outside. The text 'WABASH VALLEY' is overlaid in the top right corner in a light blue font, and 'Always There' is overlaid in a larger white font to its right.

WABASH VALLEY Always There

For over 30 years, Wabash Valley Site Furnishings has offered a variety of durable, functional, high-end furnishings including commercial-grade benches, waste receptacles, picnic tables, grills, bike racks and more. Our commercial outdoor furniture is ideal for a wide range of industries and applications and is available in numerous colors, styles and finishes to fit your needs.

WHAT

We turn outdoor spaces into gathering places for people to connect and make lasting memories.

HOW

Through the strength of two manufacturing facilities, we create durable, low maintenance site amenities that provide convenience and leisure for life's cherished moments.

WHY

We all have memories of running from the playground to our mother who was sitting on a near by bench, sharing a meal with friends outside at a picnic table, or desperately needing to dispose of an arm full of trash before you can continue on with your day. We love creating environments of enjoyment and comfort, so these moments become enhanced and turn into a positive memorable experience.

Heritage Collection

Heritage Collection products feature Plastisol-coated tabletops, seats, bench seats, backs, and receptacles. Recycled plastic seat tops and trash cans are also available. Choose from eight Plastisol color options and all frameworks come in six different powder-coat options. Solid top options within the Heritage Collection can be coated in any standard powder-coat color of your choice.



SG111D



CN420R



SG303P

PLASTISOL AND POWDER COAT COLORS

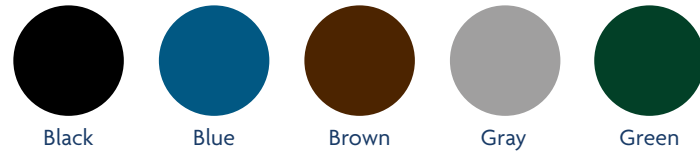

Black Blue Brown Gray Green



Purple Red Sand Yellow

RECYCLED PLASTIC LUMBER



Cedar Milwaukee Brown

Our broad selection of Plastisol-coated outdoor furniture and site amenities consist of ¼" Plastisol coating, heat-fused and permanently bonded to the steel—that's 30 times the thickness of paints and powder coatings. All Wabash Valley framework is coated with baked-on polyester dry powder, which provides a superior coating and appearance. Stainless-steel hardware is used on all products.

Colors shown here are approximate only

Urbanscape Collection

The high-end style of Wabash Valley's Urbanscape Line of powder-coated furniture fits perfectly in urban or retail environments. If rust and corrosion are a concern, Urbanscape Line has you covered with many offerings that give you a more architectural look that's built to last.



SU2238P
SU9118P



LB520N



GV2272P
GV9122P

POWDER COAT COLORS



Black Textured Black Textured Bronze Silver Tiff Blue * Rosé *

RECYCLED PLASTIC LUMBER



Cedar Milwaukee Brown Antique Mahogany

THERMORY WOOD*



Thermory®
Ash Brown

Choose from 4 standard powder coat colors and recycled plastic options. Many of the standard powder-coat colors feature a unique textured finish that creates a premium look and feel. All Urbanscape color options meet the most stringent powder-coat test specifications. Custom colors are available.



*Available for Liberty and Fairmount
Colors shown here are approximate only

Heritage Collection

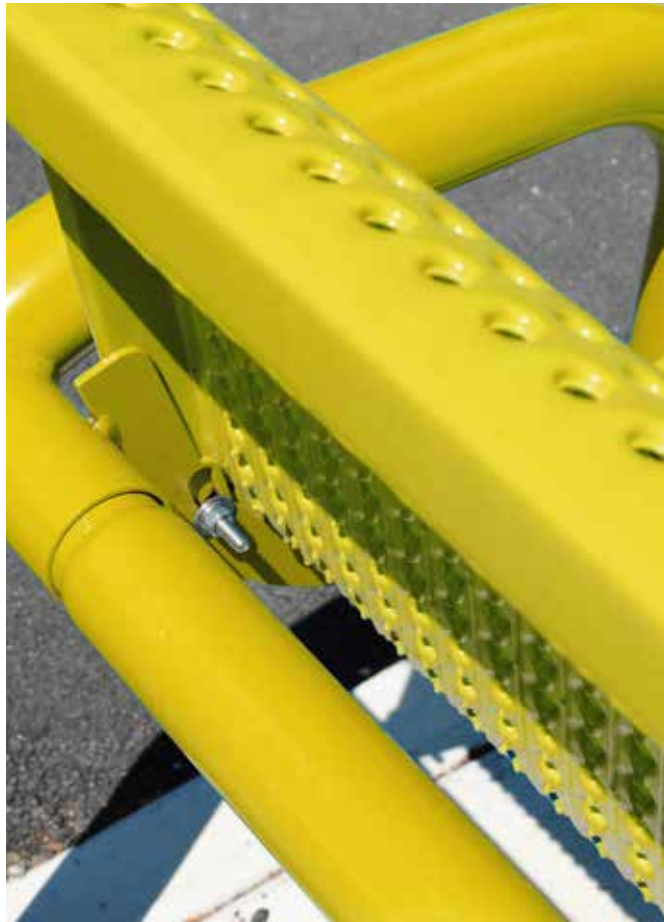
Introducing Wabash Valley's Heritage Collection – our flagship collection of Plastisol-coated outdoor furniture, crafted to endure the harshest elements and the most demanding environments. Engineered for superior durability, our Heritage products stand resilient, ensuring long-lasting performance and reliability. Whether it's a public park, a bustling urban setting, or a busy school, our extensive selection of outdoor furniture and site amenities will maintain their strength and appearance, making them the ultimate choice for any setting where durability is paramount. Experience the unmatched endurance and timeless design of Wabash Valley's Heritage Collection.

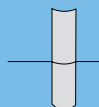

MOUNTING OPTIONS

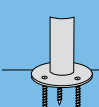
-  **IN-GROUND**
Material is embedded deep into concrete.
-  **PORTABLE**
Mount sits on top of surface and is movable.
-  **SURFACE**
Bolted to top of concrete surface with anchor bolts (not provided); all surface-mount holes are 1/2" diameter.



CAMINO

HERITAGE



The Camino Line brings a contemporary look to dining spaces with its rounded edges, and sleek, modern curves. Its uniquely designed chairs create a café-inspired aesthetic that's perfect for year-round enjoyment. Built to withstand the elements, the Camino Line offers a weather-resistant variety of colors to every outdoor dining experience, combining style and durability in every detail. Additionally, the line includes ADA-accessible options, ensuring an inclusive and welcoming space for everyone.

AVAILABLE PATTERNS

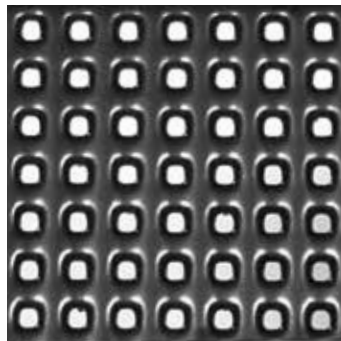

Square Perforated

AVAILABLE PLASTISOL & POWDER COAT COLORS

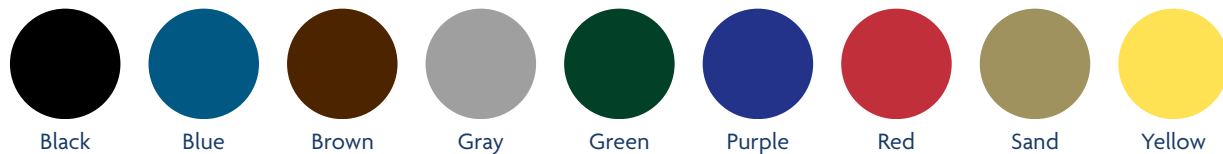

Tables



CM225Q

CAMINO | HERITAGE

			Square Perforated (Q)	
Model	Description	Mounting	Weight	
CM221	42" Round table with 4 attached chairs 🪑	Portable	270 lbs.	
CM225	42" Bar-height Round table with 4 attached chairs 🪑	Portable	346 lbs.	
CM230	42" Round table with 3 attached chairs 🪑 ♿	Surface Mount	232 lbs.	



CONTEMPORARY

HERITAGE



Looking for the perfect blend of modern aesthetics, versatility, and practicality? Our Contemporary line features stylish contoured benches that effortlessly stand out, enhancing any environment with their sleek design. Whether you're furnishing a park, plaza, or corporate campus, these benches offer a sophisticated touch that complements a wide range of settings.

Benches

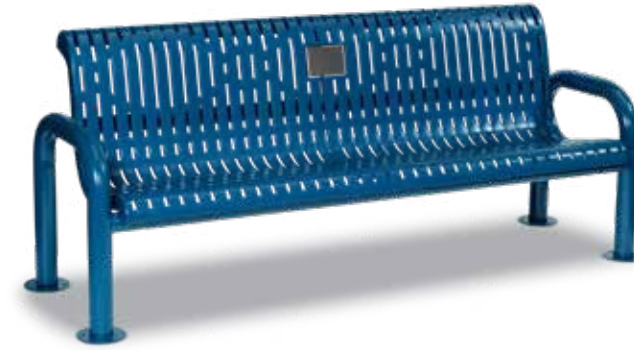

SP405R



CN430S
MC104



CN420D



CN425P

AVAILABLE PATTERNS

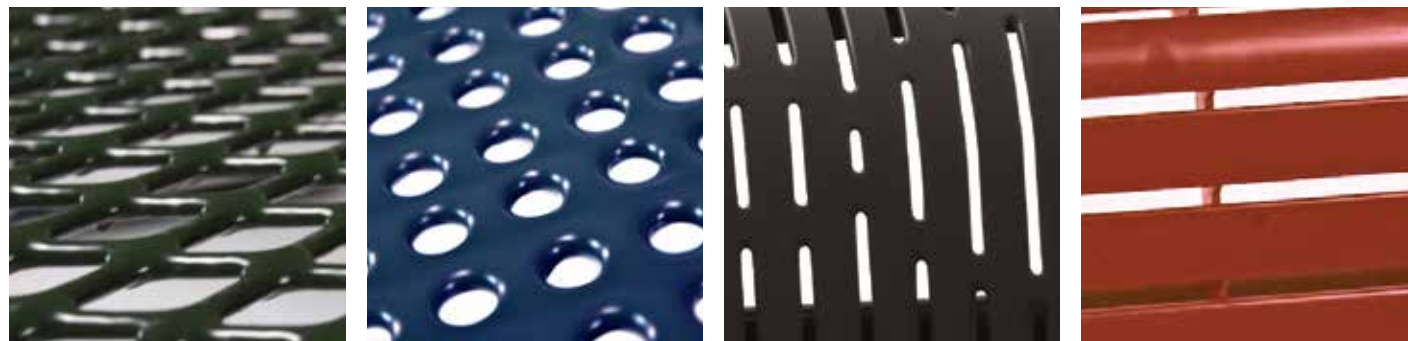

Diamond

Perforated

Rib

Slat

AVAILABLE PLASTISOL & POWDER COAT COLORS

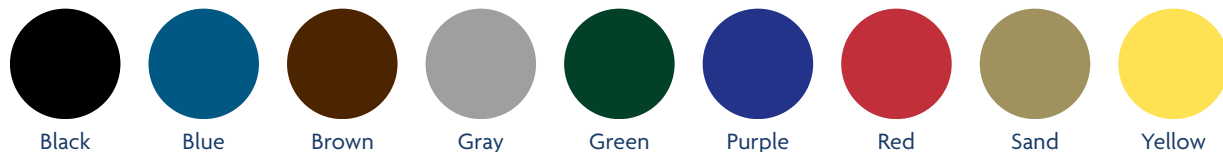

Black

Blue

Brown

Gray

Green

Purple

Red

Sand

Yellow

CONTEMPORARY | HERITAGE

Model	Description	Mounting	Diamond (D)	Perforated (P)	Rib (R)	Slat (S)
			Weight	Weight	Weight	Weight
CN420	6' Bench with back	Portable/Surface Mount	172 lbs.	195 lbs.	235 lbs.	254 lbs.
CN425	6' Bench without back	Portable/Surface Mount	157 lbs.	174 lbs.	212 lbs.	222 lbs.
CN430	6' Bench with back	Inground	163 lbs.	186 lbs.	226 lbs.	245 lbs.
CN435	6' Bench without back	Inground	159 lbs.	176 lbs.	214 lbs.	224 lbs.
SP405	6' Memorial Bench with back	Portable/Surface Mount	NA	195 lbs.	227 lbs.	NA
SP406	6' Memorial Bench with back	Inground	NA	176 lbs.	218 lbs.	NA
MC104	Mounting Plate Covers	NA	4 lbs.			

COURTYARD

HERITAGE



The Courtyard bench is one of our most popular selections, and it's easy to see why. With its clean and simple lines, Courtyard effortlessly complements diverse environments, from bustling retail areas to serene parks and gardens. Whether you choose a color that blends in or stands out, your Courtyard bench will enhance the beauty and functionality of any setting.

Benches



CY420P

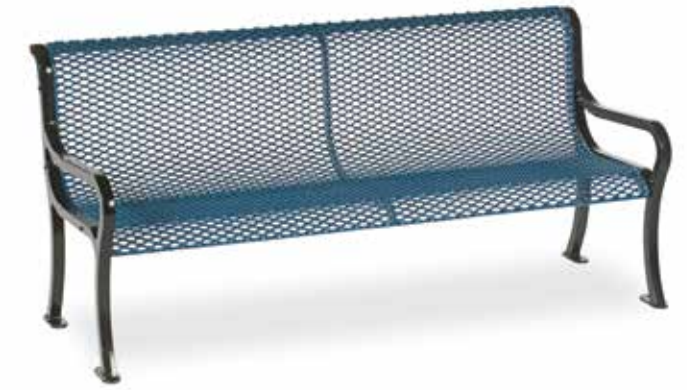

CY420D

COURTYARD | HERITAGE

Model	Description	Mounting	Diamond (D)	Perforated (P)
			Weight	Weight
CY420	6' Bench with back	Portable/Surface Mount	124 lbs.	157 lbs.
SP410P	6' Memorial Bench with back	Portable/Surface Mount	NA	157 lbs.

AVAILABLE PATTERNS



Diamond

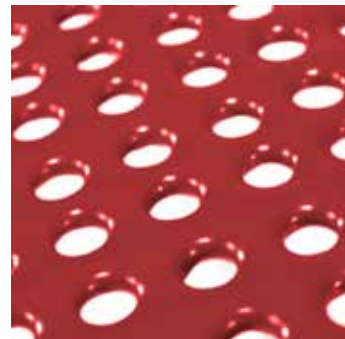

Perforated

AVAILABLE PLASTISOL & POWDER COAT COLORS



Black

Blue

Brown

Gray

Green

Purple

Red

Sand

Yellow





Bench



SP400P

ESTATE | HERITAGE

			Diamond (D)	Perforated (P)	Rib (R)
Model	Description	Mounting	Weight	Weight	Weight
SP400	6' Memorial bench with back	Portable/Surface Mount	151 lbs.	151 lbs.	200 lbs.
SW400	6' Swing bench with back	Hanging with Inground post	212 lbs.	245 lbs.	245 lbs.

The Estate Line seamlessly blends elegance with durability, offering a stunning and practical solution for any setting. Beyond its sophisticated appearance, this line is engineered for lasting performance. The bench seats are crafted with Plastisol coating, ensuring comfort and durability. Meanwhile, the high-strength aluminum-alloy permanent-mold castings deliver a premium finish and exceptional resistance to corrosion, making the Estate Line a perfect balance of beauty and resilience.

AVAILABLE PATTERNS



Diamond

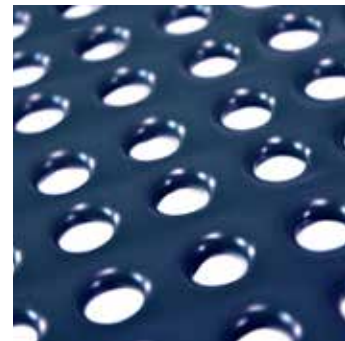

Perforated



Rib

AVAILABLE PLASTISOL & POWDER COAT COLORS



Black

Blue

Brown

Gray

Green

Purple

Red

Sand

Yellow

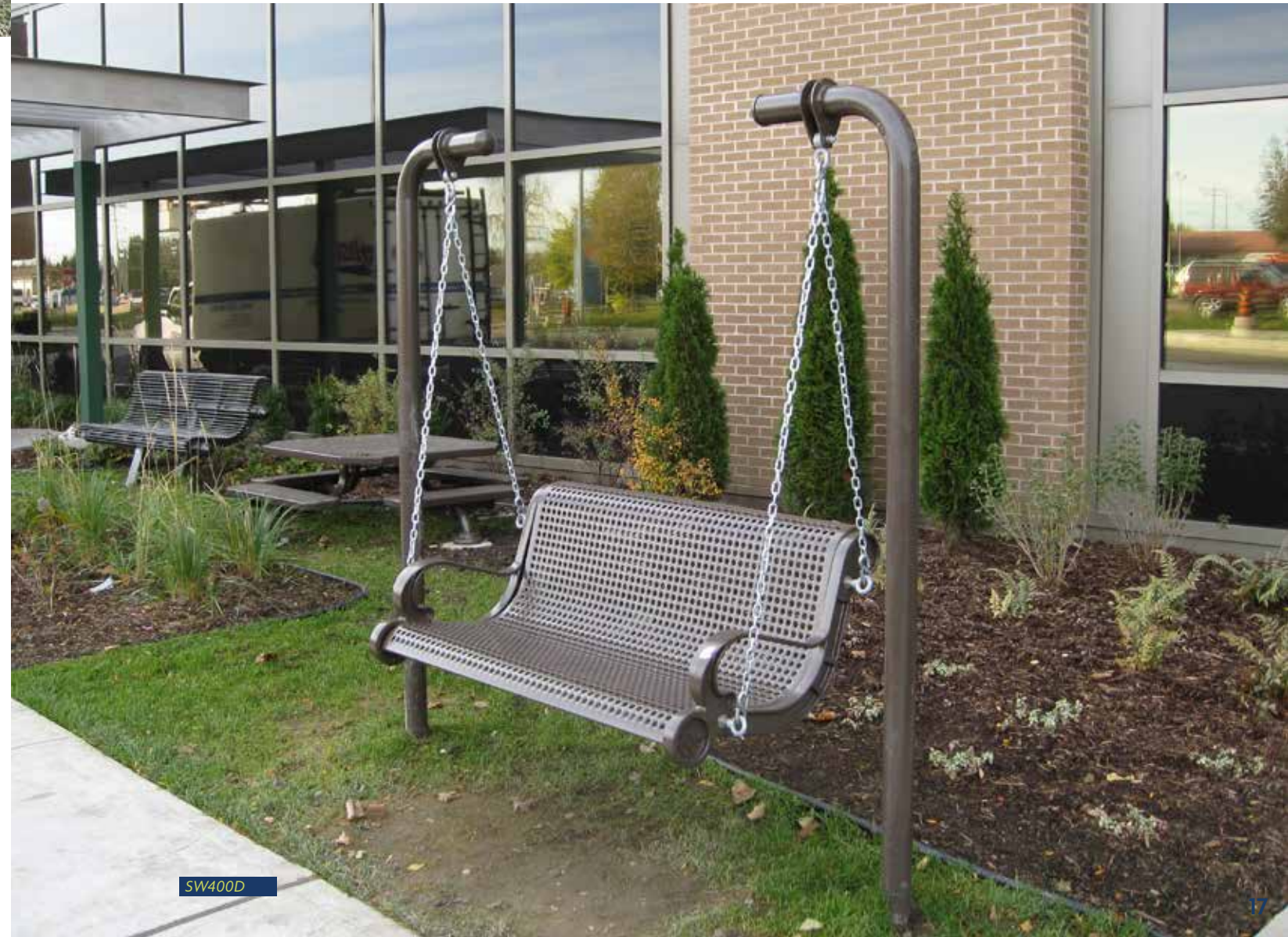

SW400D

RINNOVA

HERITAGE



Introducing the Rinnova Line, a sustainable and stylish collection that incorporates PolyTuf recycled plastic lumber, made from post consumer plastic. Rinnova offers a range of picnic tables, tables, benches, and trash receptacles. This environmentally friendly line not only provides durability and low maintenance but also promotes eco-conscious design. Each piece features sturdy, powder-coated steel bases, ensuring long-lasting performance and resistance to the elements. With its modern design and commitment to sustainability, the Rinnova Line is perfect for parks, campuses, and other outdoor spaces, providing both functionality and a reduced environmental footprint.

AVAILABLE PATTERNS

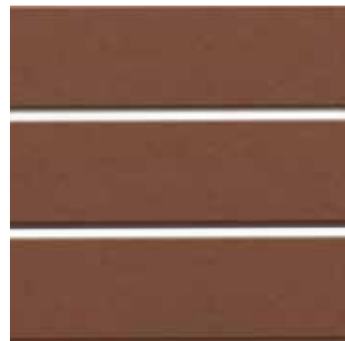

Horizontal Slats

RECYCLED PLASTIC LUMBER



Cedar



Milwaukee Brown

AVAILABLE PLASTISOL & POWDER COAT COLORS



Black Blue Brown Gray Green Purple Red Sand Yellow

Picnic Tables



RV106G



SG106D

Benches



RV301G



RV304G

RINNOVA | HERITAGE

Model	Description	Mounting	Weight	Recycled Plastic Lumber (G)
RV301G	6' Bench with back	Portable	128 lbs.	
RV302G	6' Bench without back	Portable	70 lbs.	
RV303G	6' Bench with back	Inground	127 lbs.	
RV304G	6' Bench without back	Inground	69 lbs.	
RV306G	6' Bench with back	Surface Mount	121 lbs.	
RV307G	6' Bench without back	Surface Mount	63 lbs.	
RV300G	32 Gallon receptacle w/ liner	Portable	55 lbs.	
RV400G	32 Gallon receptacle w/ liner	Inground	67 lbs.	
RV106G	6' Picnic Table	Portable	267 lbs.	
RV111G	8' Picnic Table	Portable	287 lbs.	
RV115G	8' ADA Picnic Table	Portable	276 lbs.	
RV140G	48" Square Table with 4 seats	Portable	322 lbs.	
RV229G	48" Square Table with 4 seats	Surface Mount	383 lbs.	
RV230G	48" Square Table with 4 seats	Inground	369 lbs.	
RV234G	48" Square Table with 3 seats	Surface Mount	349 lbs.	
RV235G	48" Square Table with 3 seats	Inground	355 lbs.	
RV240G	48" Square Table with 2 seats	Inground	291 lbs.	
RV245G	48" Square Table with 2 seats	Surface Mount	305 lbs.	
RV420G	6' Bench with back	Portable	160 lbs.	
RV430G	6' Bench with back	Inground	150 lbs.	

SIGNATURE



Signature Line – where timeless design meets unparalleled durability. This premium line includes a wide array of outdoor furniture, from picnic tables, benches, and trash receptacles all available in various shapes, sizes, and styles – including options sized for children. Crafted from high-quality steel and finished with our robust plastisol coating, every piece is built to withstand the elements and provide dependable performance for years to come.

AVAILABLE PATTERNS



Diamond

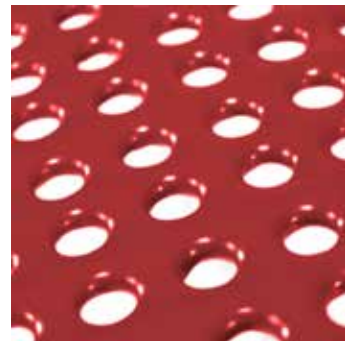

Perforated

AVAILABLE PLASTISOL & POWDER COAT COLORS



Black Blue Brown Gray Green Purple Red Sand Yellow

Picnic Tables



SG115D ♿



SG106D



SG145D



SG150D

Benches

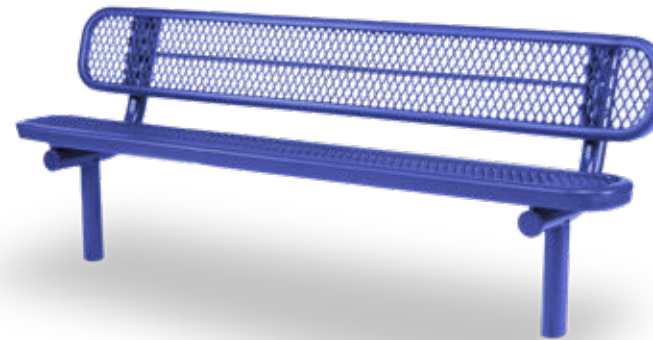

SG303D



SG306P

Model	Description	Mounting	Diamond (D) Weight	Perforated (P) Weight
SG106	6' Picnic Table	Portable	225 lbs.	257 lbs.
SG111	8' Picnic Table	Portable	270 lbs.	333 lbs.
SG111D-Solid	8' Solid top, Diamond seat Picnic Table 🦿	Portable	286 lbs.	N/A
SG115	8' ADA Picnic Table 🦿	Portable	254 lbs.	308 lbs.
SG120	10' Shelter Picnic Table	Portable	352 lbs.	N/A
SG122	10' ADA Side by Side Table 🦿	Portable	387 lbs.	N/A
SG135N	Mounting Covers for 2 3/8" Legs (set of 2)	Surface Mount	2 lbs.	2 lbs.
SG140	46" Square Picnic Table (pass thru brace for umbrella SG140DS, SG140PSF) 🦿	Portable	196 lbs.	248 lbs.
SG145	46" Octagon Picnic Table (pass thru brace for umbrella SG145DS, SG145PSF) 🦿	Portable	198 lbs.	N/A
SG150	46" Round Picnic Table (pass thru brace for umbrella SG150DS, SG150PS, SG150PSF) 🦿	Portable	198 lbs.	224 lbs.
SG155	46" Square ADA Picnic Table (pass thru brace for umbrella SG155DS, SG155PSF) 🦿🦿	Portable	213 lbs.	245 lbs.
SG171	46" Children's Square Picnic Table 🦿	Portable	177 lbs.	229 lbs.
SG176	6' Children's Square Picnic Table	Portable	142 lbs.	179 lbs.
SG178	8' Children's Intermediate Height Picnic	Portable	253 lbs.	N/A
SG205	6' Multi-Pedestal Picnic Table	Inground	302 lbs.	334 lbs.
SG206	8' Multi-Pedestal Picnic Table	Inground	347 lbs.	410 lbs.
SG207	8' Multi-Pedestal ADA Picnic Table 🦿	Inground	328 lbs.	382 lbs.
SG215	40" Square Pedestal Picnic Table 🦿	Inground	238 lbs.	279 lbs.
SG229	46" Square Pedestal Picnic Table with 4 Seats 🦿	Surface Mount	384 lbs.	385 lbs.
SG230	46" Square Pedestal Picnic Table 🦿	Inground	243 lbs.	295 lbs.
SG234	46" Square Pedestal Picnic Table with 4 Seats	Surface Mount	350 lbs.	351 lbs.
SG235	46" Square Pedestal ADA Picnic Table 🦿🦿	Inground	217 lbs.	263 lbs.
SG2448-ADA	4' ADA Bench without Back 🦿	Surface Mount	114 lbs.	N/A
SG244	46" Round Pedestal Table 🦿	Surface Mount	250 lbs.	285 lbs.
SG245	46" Round Pedestal Table 🦿	Inground	236 lbs.	271 lbs.
SG249	46" ADA Round Pedestal Table 🦿🦿	Surface Mount	223 lbs.	253 lbs.
SG250	46" ADA Round Pedestal Table 🦿🦿	Inground	209 lbs.	239 lbs.
SG300	6' Bench with Back	Portable	114 lbs.	126 lbs.
SG300BB	6' Buddy Bench with Back	Portable	N/A	126 lbs.
SG301	6' Flat Bench without Back	Portable	65 lbs.	70 lbs.
SG303	6' Bench with Back	Inground	113 lbs.	125 lbs.
SG303PBB	6' Buddy Bench with Back	Inground	N/A	125 lbs.
SG304	6' Flat Bench without Back	Inground	64 lbs.	69 lbs.
SG306	6' Bench with Back	Surface Mount	107 lbs.	119 lbs.
SG306PBB	6' Buddy Bench with Back	Surface Mount	N/A	119 lbs.
SG307	6' Flat Bench without Back	Surface Mount	58 lbs.	63 lbs.
SG312	8' Bench with Back	Portable	133 lbs.	154 lbs.
SG313	8' Flat Bench without Back	Portable	81 lbs.	90 lbs.
SG315	8' Bench with Back	Inground	132 lbs.	153 lbs.
SG316	8' Flat Bench without Back	Inground	74 lbs.	83 lbs.
SG318	8' Bench with Back	Surface Mount	126 lbs.	147 lbs.
SG319	8' Flat Bench without Back	Surface Mount	68 lbs.	77 lbs.
SG324	10' Bench with Back	Portable	187 lbs.	N/A
SG325	10' Bench without Back	Portable	104 lbs.	N/A
SG327	10' Bench with Back	Inground	182 lbs.	N/A
SG328	10' Bench without Back	Inground	97 lbs.	N/A
SG330	10' Bench with Back	Surface Mount	167 lbs.	N/A
SG331	10' Bench without Back 🦿	Surface Mount	93 lbs.	N/A
SG380	4' Bench without Back	Surface Mount	38 lbs.	N/A
SG406-ADA	6' ADA Bench with Back	Surface Mount	186 lbs.	N/A



SG250D

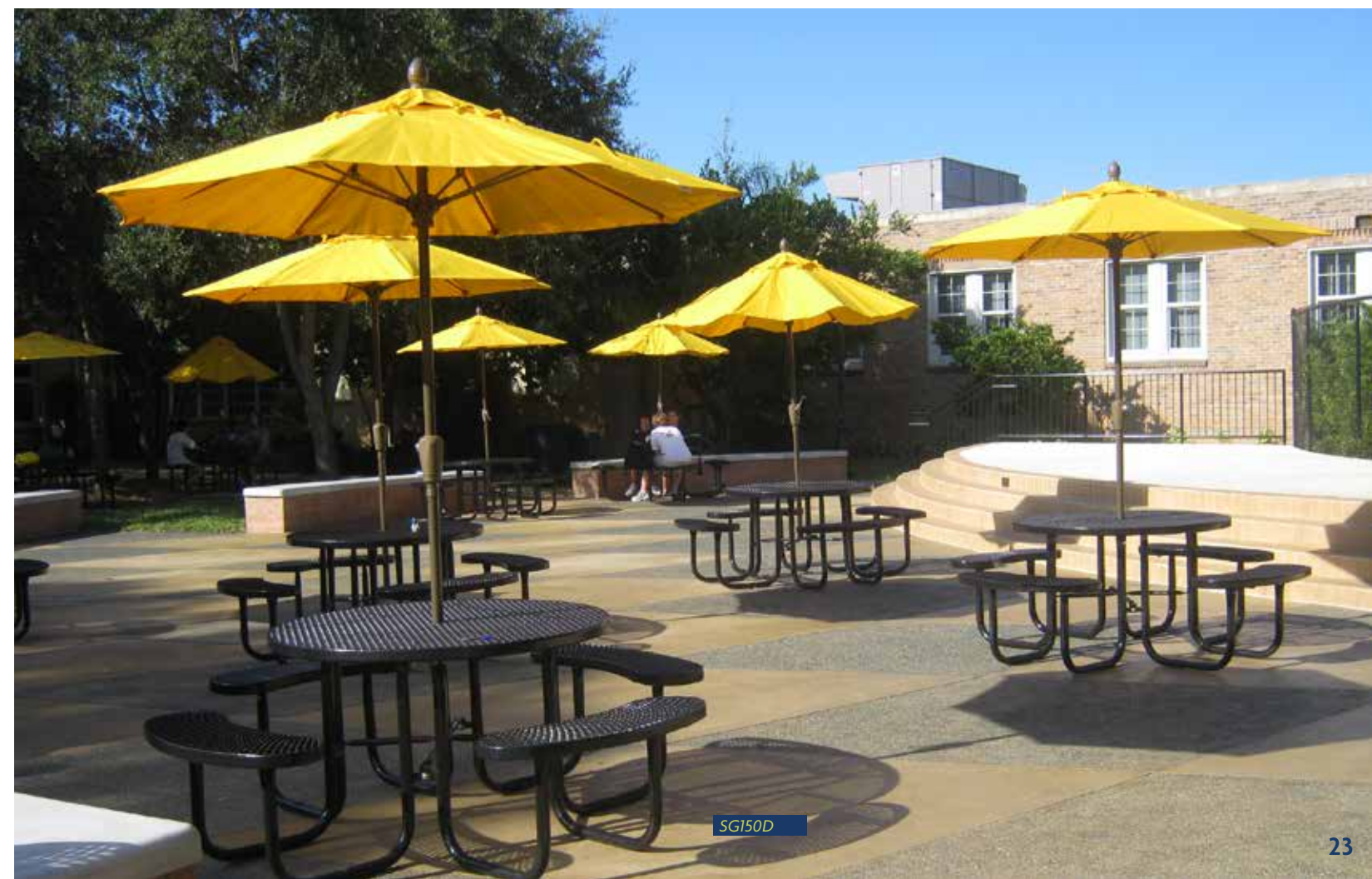

SG150D

Trash Receptacles



SIGNATURE | HERITAGE

Model	Description	Mounting	Weight
DT100N	Dome Top Lid	Portable	12 lbs.
DT101N	Recycle Dome Top Lid	Portable	7 lbs.
FT100N	Flat Top Lid - 8" Diameter. Inward Opening	Portable	9 lbs.
FT106N	Recycle Flat top Lid - 5" Diameter. Outward Slope	Portable	7 lbs.
FT110N	Flat Top Lid - 14" Diameter. Opening	Portable	8 lbs.
FT116N	Flat-top with solid bonnet for 55-gallon receptacle	Portable	16 lbs.
LR100N	Inground Post Package	Portable	12 lbs.
LR105N	Surface Mount Post Package	Portable	12 lbs.
LR200D	22 Gallon Receptacle - Diamond	Portable	57 lbs.
LR200P	22 Gallon Receptacle - Perforated	Portable	76 lbs.
LR200S	22 Gallon Receptacle - Slat	Portable	161 lbs.
LR210N	22 Gallon Liner	Portable	4 lbs.
LR300D	32 Gallon Receptacle - Diamond	Portable	67 lbs.
LR300DK	32 Gallon Receptacle Set - Diamond/Liner/Lid	Portable	83 lbs.
RV300G	32 Gallon Receptacle with liner - Recycled Plastic - Portable	Portable	55 lbs.
LR300P	32 Gallon Receptacle - Perforated	Portable	85 lbs.
LR300S	32 Gallon Receptacle - Slat	Portable	175 lbs.
LR305P	32 Gallon Receptacle with Door - Perforated	Portable	111 lbs.
LR310N	32 Gallon Liner	Portable	5 lbs.
LR350D	32 Gallon Tapered Receptacle - Diamond	Portable	37 lbs.
LR355P	55 Gallon Receptacle - Perforated	Portable	120 lbs.
LR510N	55 Gallon Liner	Portable	14 lbs.
PTD100-DBL	Paper Towel Bracket for Dispenser-Double	Portable	29 lbs.
PTD200-Single	Paper Towel Bracket for Dispenser-Single	Portable	20 lbs.
SB100N	Flat Top Solid Bonnet - Inward Opening	Portable	16 lbs.
TB100N	Flat Top w/ Tray Bonnet	Portable	21 lbs.

All items sold separately unless otherwise stated.

Game Tables



SIGNATURE | HERITAGE

Model	Description	Mounting	Weight	
			Diamond (D)	Perforated (P)
SP115	46" Round game table	Portable	200 lbs.	222 lbs.
SP120	46" Square game table	Portable	212 lbs.	240 lbs.
SP210	46" Round game table with 4 seats, Basic frame ♿	Inground	247 lbs.	269 lbs.
SP215	46" Round game table with 3 seats, Basic frame	Inground	220 lbs.	237 lbs.
SP225	46" Square game table with 4 seats, Basic frame	Inground	259 lbs.	287 lbs.
SP230	46" Square game table with 3 seats, Basic frame ♿	Inground	233 lbs.	255 lbs.

SPYDER

HERITAGE



Introducing Wabash Valley's Spyder table: a uniquely durable and versatile line of tables designed to meet diverse needs. Available in various shapes, sizes, and colors, the Spyder table offers abundant options for any setting. Its open-design legs ensure easy clean-up, and the ADA-accessible options and optional mounting plates provide added convenience and functionality.

AVAILABLE PATTERNS



Diamond

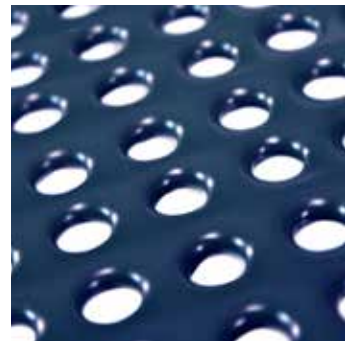

Perforated

AVAILABLE PLASTISOL & POWDER COAT COLORS



Black Blue Brown Gray Green Purple Red Sand Yellow

Picnic Tables



SY225D



SY135
MC104



SY110D

SPYDER | HERITAGE

Model	Description	Mounting	Diamond (D)	Perforated (P)
			Weight	Weight
SY110	46" Round Table ☂	Portable/Surface Mount	230 lbs.	265 lbs.
SY120	46" Square Table ☂	Portable/Surface Mount	237 lbs.	289 lbs.
SY125	46" Octagon Table ♿ ☂	Portable/Surface Mount	239 lbs.	281 lbs.
SY135	7' ADA Picnic Table ♿ ☂	Portable/Surface Mount	274 lbs.	311 lbs.
SY225	7' ADA Picnic Table ☂	Inground	303 lbs.	N/A
SP105	46" Round game table	Portable	241 lbs.	263 lbs.
SP110	46" Square game table	Portable	253 lbs.	281 lbs.



SP105D



TR300P

The Transit Line is designed for patrons in need of a comfortable resting spot while waiting for transit options. Built to withstand the elements, this durable line offers a reliable and functional solution for outdoor spaces, ensuring comfort and resilience in all weather conditions. Ideal for bus stops, train stations, and other public transit areas, the Transit Line provides both convenience and lasting performance.

AVAILABLE PATTERNS

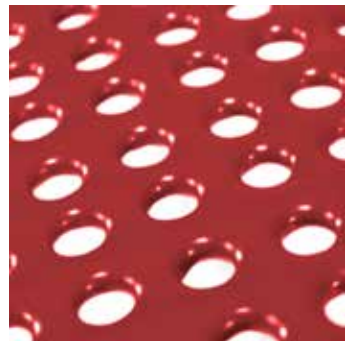

Perforated

AVAILABLE PLASTISOL & POWDER COAT COLORS



Benches



TR201P



TR202P



TR310P

TRANSIT | HERITAGE



			Perforated (P)
Model	Description	Mounting	Weight
TR201P	4' Bench without back with 3 arms and adjustable legs	Surface Mount	65 lbs.
TR202P	4' Bench without back with 1 adjustable legs	Surface Mount	70 lbs.
TR300P	4' Bench with back, arms and adjustable legs	Surface Mount	98 lbs.
TR310P	4' Bench without arms with back with adjustable legs	Surface Mount	88 lbs.

Urbanscape Collection

Within the Urbanscape Collection, many lines offer PolyTuf recycled lumber made from post-consumer plastics as a material option. This environmentally friendly material offers the look of wood, but without cracking and fading. Although the Urbanscape Collection's look is high-end, it isn't high-priced. Our collection can fit any budget just as well as we fit into almost any landscape. So you get a head-turning look without the eye-popping costs—just one more way the Urbanscape Collection is the smarter choice.

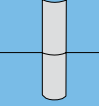

MOUNTING OPTIONS

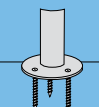
-  **IN-GROUND**
Material is embedded deep into concrete.
-  **PORTABLE**
Mount sits on top of surface and is movable.
-  **SURFACE**
Bolted to top of concrete surface with anchor bolts (not provided); all surface-mount holes are 1/2" diameter.

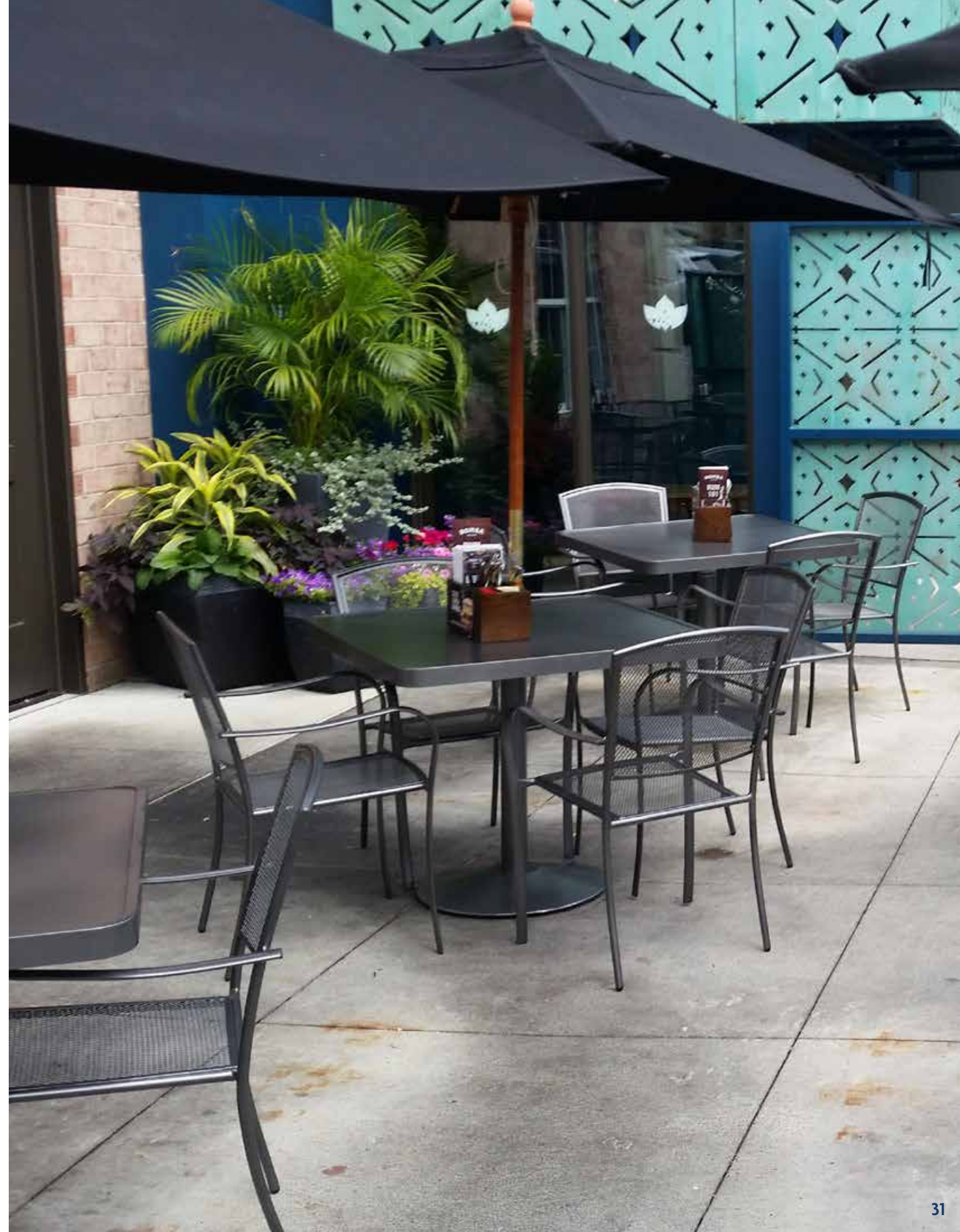

BUTLER



The Butler Line offers a refined look with decorative side casting details. Its bold design uses strong lines and angles to create a unique and eye-catching profile, making a statement in any space. With aluminum seats and sturdy aluminum frames, it delivers both versatility and long-lasting durability, perfect for enhancing outdoor or indoor settings.

AVAILABLE PATTERNS



Horizontal Slat

AVAILABLE POWDER COAT COLORS



Bench



BU1119C

BUTLER | URBANSCAPE

Model	Description	Mounting	Weight
BU1119C	6' Bench with Back & Arms	Portable/Surface Mount	119 lbs.



COVINGTON



The Covington line, where we move beyond the basics to offer a perfect blend of simplicity and elegance. The smooth, cast aluminum design, coupled with a contoured seat, gives the Covington bench a refined appearance that is both understated and sophisticated. This line is crafted to provide comfort and style, making it an ideal choice for any setting for a casual outdoor space or a more formal environment.

AVAILABLE PATTERNS



Horizontal Slat

AVAILABLE POWDER COAT COLORS



Black

Silver

Textured Bronze

Textured Black

Bench

CO1119C



COVINGTON | URBANSCAPE

Model	Description	Mounting	Weight
CO1119C	6' Bench with Back & Arms	Portable/Surface Mount	108 lbs.



FAIRMOUNT



Designed with comfort and style in mind, this modular line of commercial-grade outdoor furniture features unique sections that can be mixed and matched to create a customized seating or dining area. The Fairmount product line blends harmoniously with the surrounding environment and helps create an inviting outdoor space for all to enjoy.

- Thermory® is 100% sustainably harvested North American White Ash.
- A chemical free heat and steam process gives the wood rot resistance and stability.
- Plank color can be maintained with a penetrating oil to reflect UV rays or will naturally season to a beautiful silver-gray color if left untreated.
- Structural steel framing is strong, durable and enhanced by protective powder coating.
- Fasteners and assembly hardware included. Surface mount hardware not included.

AVAILABLE PATTERNS



Horizontal Slat

THERMORY WOOD



Thermory®
Ash Brown

AVAILABLE POWDER COAT COLORS



Black

Silver

Textured
Bronze

Textured
Black

Tiff Blue

Rosé

Curved Benches

SMALL RADIUS CURVES



FA140N



FA160N



FA180N



FA200N



FA220N

LARGE RADIUS CURVES



FA240N



FA260N



FA280N



FA300N

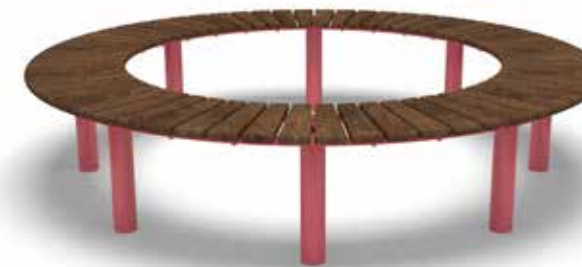

FA320N



FA340N

Bar Tables & Stools



FA360N



FA380N



FA400N



FA420N

Straight Benches & Tables



FA100N



FA440N



FA120N



FA460N



FA480N



FAIRMOUNT | URBANSCAPE

Model	Description	Mounting	Weight
FA100N	69" Bench with back	Portable/Surface Mount	102 lbs.
FA120N	43" Round Table	Portable/Surface Mount	46 lbs.
FA140N	45° Curved Stool - small radius	Inground	17 lbs.
FA160N	45° Curved Stool - small radius	Portable/Surface Mount	8 lbs.
FA180N	90° Curved Bench - small radius	Portable/Surface Mount	35 lbs.
FA200N	59" Curved Bench 360°	Inground	155 lbs.
FA220N	59" Curved Bench 360°	Portable/Surface Mount	335 lbs.
FA240N	45° Curved Stool - large radius	Inground	22 lbs.
FA260N	45° Curved Stool - large radius	Portable/Surface Mount	15 lbs.
FA280N	90° Curved Bench - large radius	Inground	57 lbs.
FA300N	90° Curved Bench - large radius	Portable/Surface Mount	59 lbs.
FA320N	83" Curved Bench 360°	Inground	203 lbs.
FA340N	83" Curved Bench 360°	Portable/Surface Mount	251 lbs.
FA360N	24" Bar Table	Inground	45 lbs.
FA380N	24" Bar Table	Portable/Surface Mount	48 lbs.
FA400N	45° Curved Bar Stool	Portable/Surface Mount	23 lbs.
FA420N	Bar Furniture Set	Portable/Surface Mount	138 lbs.
FA440N	69" Park Bench with back	Inground	66 lbs.
FA460N	51" Table	Portable/Surface Mount	50 lbs.
FA480N	69" Park Bench without back	Portable/Surface Mount	50 lbs.



Green Valley products offer environmentally friendly alternatives. Constructed with PolyTuf plastic lumber custom-extruded from recycled plastics, Green Valley benches and picnic tables are long-lasting and nearly maintenance-free. They also don't have the drawbacks of real wood, such as fading, insects, cracking and splintering.

Unlike most wood and wood-composite products that quickly fade when exposed to the weather, the PolyTuf surfaces have no wood fibers, so they retain their vibrant look for years. In addition, they don't need waterproofing, staining or any maintenance other than an occasional washing with soap and water.

AVAILABLE PATTERNS



Horizontal Slat

RECYCLED PLASTIC LUMBER



Cedar



Antique Mahogany



Milwaukee Brown

AVAILABLE POWDER COAT COLORS



Black



Silver

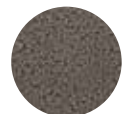

Textured Bronze



Textured Black



GV2Z72P
GV9I22P



GV2X72P
GV9I22P



Tables



GV2Y72P



GVA5E2P

Chairs



GV9I12P



GVBI22P

GREEN VALLEY | URBANSCAPE

Model	Description	Mounting	Weight
GV2072P	30"x24" Rectangular Dining Table	Portable	33 lbs.
GV2V72P	36" Square Dining Table ☂	Portable	52 lbs.
GV2X72P	30" Square Dining Table	Portable	38 lbs.
GV2Y72P	48" Square Dining Table ☂	Portable	72 lbs.
GV2Z72P	30"x48" Rectangular Dining Table ☂	Portable	50 lbs.
GV9I12P	Dining Chair with Arms	Portable	19 lbs.
GV9I22P	Dining Chair without Arms	Portable	18 lbs.
GVA5E2P	30"x72" Rectangular Bar Table	Portable	80 lbs.
GVAV72P	36" Square Bar Table	Portable	56 lbs.
GVAX72P	30" Square Bar Table	Portable	42 lbs.
GVBI22P	Bar Chair	Portable	22 lbs.

HANNA



Introducing the Hanna line, featuring clean lines and classic style for a stylish and comfortable spot for dining or relaxing. With its sleek design and durable construction, the Hanna line offers both form and function, making it perfect for any environment. Available in four colors, this line brings a cozy feel to any space while ensuring long-lasting performance.

AVAILABLE PATTERNS



Horizontal Slat

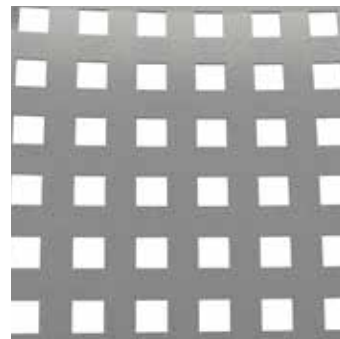

Large Square Perforated

AVAILABLE POWDER COAT COLORS

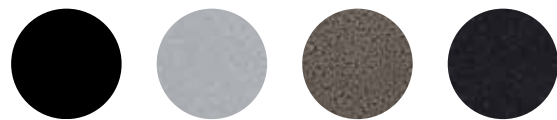

Black

Silver

Textured Bronze

Textured Black

Tables



HAA179P



HA2Z79P

Chairs



HA9119P



HA2V79P
HA911AP

HANNA | URBANSCAPE

Model	Description	Mounting	Weight
HA2177P	36" Round Pedestal Dining Table - Solid ☂	Portable	77 lbs.
HA2179P	36" Round Pedestal Dining Table - Horizontal Slat ☂	Portable	77 lbs.
HA2V79P	36" Square Pedestal Dining Table - Horizontal Slat ☂	Portable	77 lbs.
HA2Z79P	30" x 48" Rectangular Pedestal Dining Table - Horizontal Slat ☂	Portable	80 lbs.
HA3D33P	Receptacle Slat with Liner & Dome Lid	Portable	77 lbs.
HA9119P	Dining Chair without arms - Horizontal Slat	Portable	11 lbs.
HA911AP	Dining Chair with arms - Large Square Perforated	Portable	11 lbs.
HA9121P	Dining Chair without arms - Large Square Perforated	Portable	11 lbs.
HA9129P	Dining Chair without arms - Horizontal Slat	Portable	11 lbs.
HAA5E7P	30" x 72" Rectangular Community Table - Solid	Portable	158 lbs.
HAA5E9P	30" x 72" Rectangular Community Table - Horizontal Slat	Portable	158 lbs.
HAA177P	36" Round Pedestal Bar Table - Solid	Portable	77 lbs.
HAA179P	36" Round Pedestal Bar Table - Horizontal Slat	Portable	77 lbs.
HAB121P	Bar Chair without arms - Large Square Perforated	Portable	17 lbs.



A modular system that allows you to create a space just the way you want it. The Liberty product line has a variety of products from bins to planters, tables to seating - providing a complete and seamless look.

- Thermory® is 100% sustainably harvested North American White Ash.
- A chemical free heat and steam process gives the wood rot resistance and stability.
- Plank color can be maintained with a penetrating oil to reflect UV rays or will naturally season to a beautiful silver-gray color if left untreated.
- Structural steel framing is strong, durable and enhanced by protective powder coating.
- Fasteners and assembly hardware included. Surface mount hardware not included.

AVAILABLE PATTERNS



Horizontal Slat

THERMORY WOOD



Thermory®
Ash Brown

AVAILABLE POWDER COAT COLORS



Black Silver Textured Bronze Textured Black Tiff Blue Rosé

Tables, Extensions & Planters Module

MODULE 1 - Small Square 23.6" (0.6m) x 23.6" (0.6m)



LB240N



LB180N



LB400N



LB420N



LB120N

MODULE 2 - Small Hexagon 27" (0.68m) x 23.6" (0.6m)



LB260N



LB200N



LB460N



LB440N



LB140N

MODULE 3 - Large Hexagon 47" (1.19m) x 40.9" (1.03m)



LB220N



LB380N



LB280N



LB480N



LB160N

Straight Benches



LB520N



LB540N



LB340N



LB560N



LB580N



LB320N



Accessories



LB300N



LB500N

Receptacles



LB360N



LB365N



LB370N



LB375N



LB105N

LIBERTY | URBANSCAPE

Model	Description	Mounting	Weight
LB105N	Bike Rack	Surface Mount	37 lbs.
LB120N	24" Trellis Square	Mounts to Extension	102 lbs.
LB140N	27" Trellis Hexagonal Small	Mounts to Extension	93 lbs.
LB160N	47" Trellis Hexagonal Large	Mounts to Extension	161 lbs.
LB180N	24" Extension Module Square	Portable/Surface Mount	55 lbs.
LB200N	27" Extension Module Hexagonal Small	Portable/Surface Mount	48 lbs.
LB220N	47" Extension Module Hexagonal Large	Portable/Surface Mount	103 lbs.
LB240N	24" Planter Square	Mounts to Extension	69 lbs.
LB260N	27" Planter Hexagonal Small	Mounts to Extension	63 lbs.
LB280N	47" Planter Hexagonal Large	Mounts to Extension	121 lbs.
LB300N	Armrest for Bench	Mounts to Bench	17 lbs.
LB320N	69" Table (Must be connected to planter or extension)	Portable/Surface Mount	122 lbs.
LB340N	69" Bench with Leg and Armrest (Must be connected to planter or extension)	Portable/Surface Mount	123 lbs.
LB360N	Trash Receptacle, Paper	Portable/Surface Mount	189 lbs.
LB365N	Trash Receptacle, Plastic	Portable/Surface Mount	189 lbs.
LB370N	Trash Receptacle, Glass	Portable/Surface Mount	189 lbs.
LB375N	Trash Receptacle, Metal	Portable/Surface Mount	189 lbs.
LB380N	47" Planter Seat Hexagonal Large	Mounts to Extension	52 lbs.
LB400N	24" Seat Square	Mounts to Extension	27 lbs.
LB420N	24" Wood Frame Square	Mounts to Extension	18 lbs.
LB440N	27" Seat Hexagonal Small	Mounts to Extension	36 lbs.
LB460N	27" Wood Frame Hexagon Small	Mounts to Extension	18 lbs.
LB480N	47" Wood Frame Hexagon Large	Mounts to Extension	22 lbs.
LB500N	Micro Table	Portable/Surface Mount	15 lbs.
LB520N	69" Bench	Portable/Surface Mount	35 lbs.
LB540N	69" Bench with Leg (Must be connected to planter or extension)	Portable/Surface Mount	108 lbs.
LB560N	69" Bench with back (Must be connected to planter or extension on both sides)	Portable/Surface Mount	112 lbs.
LB580N	69" Bench with one leg and back (Must be connected to planter or extension)	Portable/Surface Mount	127 lbs.

Designed Sets

Need some help? Our pre-designed sets are available and ready to go, to fit your space right away.

Bench with back and large hexagon module



Bench without back and square module



Table and large hexagon and extension module



Bench with back and large hexagon module



Bench without back and square module



Table and large hexagon and extension module





Discover the Oxford line from Wabash Valley, featuring stylish and durable outdoor furniture designed to enhance any urban outdoor space. The Oxford bench combines timeless elegance with robust construction, making it the perfect addition to parks, streetscapes, and public places. With a focus on both form and function, the Oxford line ensures lasting comfort and aesthetic appeal in any setting.

AVAILABLE PATTERNS



Horizontal Slat



Vertical Slat

AVAILABLE POWDER COAT COLORS



Black



Silver

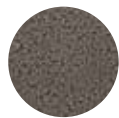

Textured Bronze



Textured Black

Benches

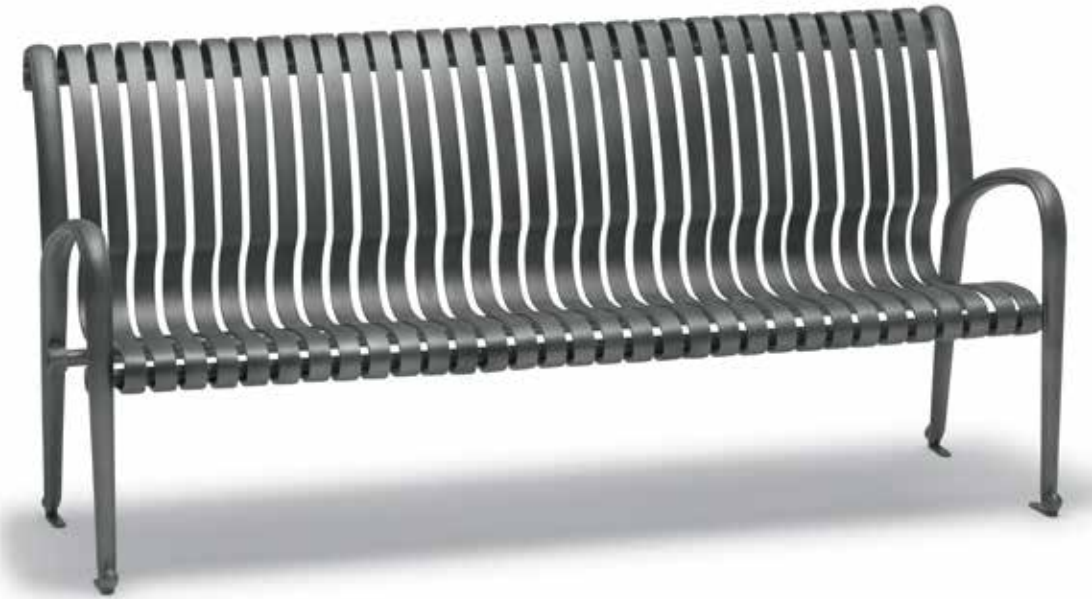

OX1113C

Receptacles



TJ3B33P

OXFORD | URBANSCAPE

Model	Description	Mounting	Weight
OX1113C	6' Bench w/back, with arms - Slat	Portable/Surface Mount	136 lbs.
OX1119C	6' Bench w/back, with arms - Horizontal Slat	Portable/Surface Mount	117 lbs.
TJ3B43P	Receptacle with Side Door - with Liner and Bonnet Lid - Slat	Portable	103 lbs.
TJ3B33P	Receptacle - with Liner and Flat-Top Lid - Slat	Portable	88 lbs.

SULLIVAN

URBANSCAPE



The Sullivan line offers a sensible seating solution for the cost-conscious business. The simple, slim lines are designed to complement any outdoor space without distracting patrons. You can select from a round, square or rectangle table to fit your space perfectly. Plus, the chairs are stackable for easy storage. Practicality never looked so good.

AVAILABLE PATTERNS



Mesh

AVAILABLE POWDER COAT COLORS

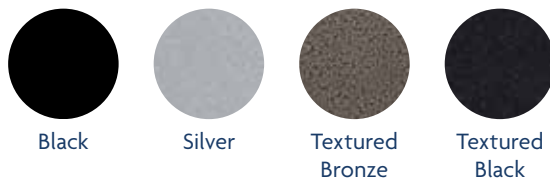

Black

Silver

Textured Bronze

Textured Black

Tables



SU2V38P

Chairs



SU9118P



SU2H38P
SU9118P

SULLIVAN | URBANSCAPE

Model	Description	Mounting	Weight
SU2G38P	48" Round Table ☂	Portable	31 lbs.
SU2H38P	42" Round Table ☂	Portable	27 lbs.
SU2I38P	36" Round Table ☂	Portable	24 lbs.
SU2V38P	36" Square Table ☂	Portable	26 lbs.
SU2W38P	42" Square Table ☂	Portable	31 lbs.
SU2X38P	30" Square Table ☂	Portable	21 lbs.
SU2Z38P	30 x 48 Table ☂	Portable	30 lbs.
SU9118P	Dining Chair with arms	Portable	11 lbs.

WOODRIDGE

URBANSCAPE



The Woodridge line offers a more sculptural interpretation of traditional benches. The expressive, one-piece legs and arms draw attention to patrons, and they're available in several powder-coated colors, further accentuate their shapes. These beautiful, soft-angled forms cradle the seat and back in a graceful curve, lending a visually playful and welcoming effect.

AVAILABLE PATTERNS



Horizontal Slat

AVAILABLE POWDER COAT COLORS



Black

Silver

Textured Bronze

Textured Black

Benches



WO1119S



WO1419S

WOODRIDGE | URBANSCAPE

Model	Description	Mounting	Weight
WO1119S	6' Bench with back with arms	Surface Mount	140 lbs.
WO1419S	6' Bench without back with arms	Surface Mount	124 lbs.

YORKTOWN

URBANSCAPE



Introducing Wabash Valley's Yorktown line, where choice and elegance come together to create a truly unique environment. The Yorktown line offers a variety of captivating bench-style designs and beautiful chair options, allowing you to customize your space effortlessly. Complement the seating with stylish round or rectangular tables to enhance the aesthetic appeal of any setting.

AVAILABLE PATTERNS



Chippendale



Vertical Slat

AVAILABLE POWDER COAT COLORS

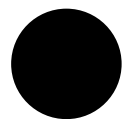

Black



Silver

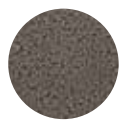

Textured Bronze



Textured Black

Benches



YO1213C

Receptacles



YO3F33C



YO2G33C
YO9113C

YORKTOWN | URBANSCAPE

Model	Description	Mounting	Weight
YO1113C	6' Bench straight back, with arms – Vertical Slat	Portable/Surface Mount	74 lbs.
YO1213C	6' Bench arch back, with arms – Vertical Slat	Portable/Surface Mount	79 lbs.
YO1313C	6' Bench straight back, with arms – Chippendale	Portable/Surface Mount	87 lbs.
YO2G33C	48" Round table – Vertical Slat ☂	Portable/Surface Mount	55 lbs.
YO2K33C	36" x 72" Rectangular table – Vertical Slat ☂	Portable/Surface Mount	70 lbs.
YO3F33C	Receptacle with liner – Vertical Slat	Portable/Surface Mount	76 lbs.
YO9113C	Dining Chair – Vertical Slat	Portable	48 lbs.



YO1313C

BIKE RACKS



BRK534S



BIKE RACKS | ACCESSORIES

Model	Description	Mounting	Weight
BRH538I	Courtyard Bike Loop	Inground	25 lbs.
BRH538S	Courtyard Bike Loop	Surface Mount	34 lbs.
BRH539I	Urbanscape Circular Bike Rack	Inground	34 lbs.
BRH539S	Urbanscape Circular Bike Rack	Surface Mount	34 lbs.
BRH540I	Inverted U Bike Rack	Inground	34 lbs.
BRH540S	Inverted U Bike Rack	Surface Mount	34 lbs.
BRH541I	Bike Rack Circular - Stainless	Inground	34 lbs.
BRH541S	Bike Rack Circular - Stainless	Surface Mount	34 lbs.
BRH542I	Bike Rack Circular	Inground	34 lbs.
BRH542S	Bike Rack Circular	Surface Mount	34 lbs.
BRH543I	Open Circular Bike Rack - Stainless	Inground	34 lbs.
BRH543S	Open Circular Bike Rack - Stainless	Surface Mount	34 lbs.
BRH544I	Open Circular Bike Rack	Inground	34 lbs.
BRH544S	Open Circular Bike Rack	Surface Mount	34 lbs.
BRH545I	Designer Bike Rack – Stainless	Inground	34 lbs.
BRH545S	Designer Bike Rack – Stainless	Surface Mount	34 lbs.
BRH546I	Designer Bike Rack – Powder coat	Inground	34 lbs.
BRH546S	Designer Bike Rack – Powder coat	Surface Mount	34 lbs.
BRI538P	8 Bike Rack – Double Sided	Portable	69 lbs.
BRK534S	5 Loop, 7 Bike Rack - Serpentine	Surface Mount	43 lbs.
BRK538I	3 Loop, 5 Bike Rack - Serpentine	Inground	43 lbs.
BRK538S	3 Loop, 5 Bike Rack - Serpentine	Surface Mount	48 lbs.

GRILLS & FIRE RINGS



GR106N

To round out our full line of outdoor furnishings, Wabash Valley is showcasing below our outdoor grill and fire ring selections. Choose from several sizes and attributes, all coated in non-toxic heat- and rust-resistant black enamel.



GRILLS | ACCESSORIES

Model	Description	Mounting	Weight
GR100N	Pedestal Grill – 300 sq. inches – Adjustable & Flippable Grate	Inground	79 lbs.
GR101N	Pedestal Grill – 300 sq. inches – Adjustable-only Grate	Inground	79 lbs.
GR102N	Group Grill	Surface Mount	246 lbs.
GR103N	Fire Ring with Tilt-back Staples	Inground	86 lbs.
GR104N	Group Grill with one side shelf	Surface Mount	460 lbs.
GR105N	Covered Grill - 500 sq. inches	Inground	188 lbs.
GR106N	Fire Ring with spade anchors	Inground	95 lbs.
GR107N	Accessible Pedestal Grill - 300 sq. inches – Swivel Grate ♿	Surface Mount	76 lbs.
GR108N	Accessible Fire Ring – Swivel Grate ♿	Inground	119 lbs.

HAGS Collection

Wabash Valley is excited to announce our role as an official distributor of HAGS products. With this new addition, we now offer a broader range of high-quality outdoor site amenities. This opens up exciting opportunities for schools, municipalities, and organizations looking to enhance their spaces. This partnership sets us apart from our competitors as HAGS is a globally recognized leader in the industry.





Ekeby is robust and stylish furniture with minimalist elegance, suitable for most environments. Its simple, practical design ensures lasting enjoyment in everyday life. Available in various colors and High-Pressure Laminate (HPL), Ekeby fits perfectly in both urban and rural settings. Explore our range of durable park benches and tables, designed for comfort and social interaction in public spaces. Ideal for walkways, squares, shopping centers, and parks, these benches come in various designs and colors, enhancing outdoor enjoyment and providing ideal spots for relaxation and social interaction.

AVAILABLE HPL COLORS



Beige

Green

Gray

AVAILABLE FRAME COLORS

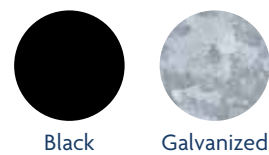

Black

Galvanized

Benches

Tables



EKEBY | HAGS

Model	Description	Color	Mounting	Weight
8101175	69" Bench without back	Green/Black	Inground	54 lbs.
8101176	69" Bench without back	Gray/Black	Inground	54 lbs.
8101177	69" Bench without back	Beige/Black	Inground	54 lbs.
8101178	69" Bench without back	Green/Galvanized	Inground	54 lbs.
8101180	69" Bench without back	Gray/Galvanized	Inground	54 lbs.
8101181	69" Bench without back	Beige/Galvanized	Inground	54 lbs.
8101199	69" Bench without back	Green/Black	Surface Mount	59 lbs.
8101201	69" Bench without back	Green/Black	Surface Mount	59 lbs.
8101202	69" Bench without back	Green/Black	Surface Mount	59 lbs.
8101204	69" Bench without back	Green/Galvanized	Surface Mount	59 lbs.
8101205	69" Bench without back	Gray/Galvanized	Surface Mount	59 lbs.
8101207	69" Bench without back	Beige/Galvanized	Surface Mount	59 lbs.
8101265	69" Bench with back	Green/Black	Inground	69 lbs.
8101266	69" Bench with back	Gray/Black	Inground	69 lbs.
8101267	69" Bench with back	Beige/Black	Inground	69 lbs.
8101268	69" Bench with back	Green/Galvanized	Inground	69 lbs.
8101269	69" Bench with back	Gray/Galvanized	Inground	69 lbs.
8101271	69" Bench with back	Beige/Galvanized	Inground	69 lbs.
8101284	69" Bench with back	Green/Black	Surface Mount	82 lbs.
8101285	69" Bench with back	Green/Black	Surface Mount	82 lbs.
8101286	69" Bench with back	Green/Black	Surface Mount	82 lbs.
8101287	69" Bench with back	Green/Galvanized	Surface Mount	82 lbs.
8101288	69" Bench with back	Gray/Galvanized	Surface Mount	82 lbs.
8101289	69" Bench with back	Beige/Galvanized	Surface Mount	82 lbs.
8101144	51" Table	Green/Black	Inground	70 lbs.
8101147	51" Table	Gray/Black	Inground	70 lbs.
8101154	51" Table	Beige/Black	Inground	70 lbs.
8101157	51" Table	Green/Galvanized	Inground	70 lbs.
8101158	51" Table	Gray/Galvanized	Inground	70 lbs.
8101159	51" Table	Beige/Galvanized	Inground	70 lbs.
8101162	51" Table	Green/Black	Surface Mount	78 lbs.
8101163	51" Table	Green/Black	Surface Mount	78 lbs.
8101164	51" Table	Green/Black	Surface Mount	78 lbs.
8101165	51" Table	Green/Galvanized	Surface Mount	78 lbs.
8101171	51" Table	Gray/Galvanized	Surface Mount	78 lbs.
8101174	51" Table	Beige/Galvanized	Surface Mount	78 lbs.

PICNIC TABLES



Explore our range of picnic tables, designed to enhance community gatherings and provide comfortable seating in any outdoor setting. Built to withstand various climates, our tables come in HPL, including wheelchair-accessible designs, making them ideal for all public spaces.

- Skagen: An attractive meeting spot for all ages and abilities, featuring ergonomic design for the elderly or those with limited mobility. The standard unit includes seven or eight seats and accommodates one wheelchair user.
- Linnea: Features a sleek, modern design that complements any outdoor setting. Made from high-quality materials, it resists fading, rusting, and wear, ensuring long-lasting durability with minimal maintenance.
- Olvon: A practical and versatile piece, perfect for parks, picnic areas, campgrounds, or any outdoor space. Constructed with high-quality materials, it offers a sturdy frame and durable tabletop and bench seats, ensuring longevity even in harsh weather conditions.

AVAILABLE HPL COLORS



Beige

Green

Gray

AVAILABLE FRAME COLORS



Galvanized



8100868

SKAGEN | HAGS

Model	Description	Color	Mounting	Weight
8100861	69" Square Picnic Table	Green/Galvanized	Surface Mount	222 lbs.
8100868	69" Square Picnic Table	Gray/Galvanized	Surface Mount	222 lbs.
8100870	69" Square Picnic Table	Beige/Galvanized	Surface Mount	222 lbs.



8101055

LINNEA | HAGS

Model	Description	Color	Mounting	Weight
8101055	69" Picnic Table	Green/Galvanized	Surface Mount	178 lbs.
8101056	69" Picnic Table	Gray/Galvanized	Surface Mount	178 lbs.
8101057	69" Picnic Table	Beige/Galvanized	Surface Mount	178 lbs.



8101378

OLVON | HAGS

Model	Description	Color	Mounting	Weight
8101369	85" Picnic Table	Green/Galvanized	Surface Mount	186 lbs.
8101375	85" Picnic Table	Gray/Galvanized	Surface Mount	185 lbs.
8101378	85" Picnic Table	Beige/Galvanized	Surface Mount	188 lbs.



Explore our range of durable benches, expertly designed for outdoor use. Made from high-quality materials, these benches withstand the elements while retaining their aesthetic appeal. Ideal for parks, walkways, and gardens, they offer convenient seating for relaxation and social interaction.

- **Esplanad:** With a classic, timeless design, this bench seamlessly blends into any outdoor setting. Clean lines, curved armrests, and a slatted seat and backrest contribute to its elegance, making it a focal point in parks or public spaces. Crafted from weather-resistant, durable materials, which ensures long-lasting performance in various climates.
- **Grid:** Featuring a bold graphic striped pattern and smooth finish, this range adds a contemporary touch to any space, indoors or outdoors. Benches can be combined to create unique configurations tailored to your budget or space. Made with steel and HPL slats, it offers a durable, low-maintenance solution. Designer: Lars Vejen.

AVAILABLE COLORS



Silver



Gray



8003205

ESPLANAD | HAGS

Model	Description	Color	Mounting	Weight
8003205	73" Park Bench with back	Silver	Surface Mount	164 lbs.
8003211	73" Park Bench with back	Silver	Inground	115 lbs.



8029283

GRID | HAGS

Model	Description	Color	Mounting	Weight
8029282	71" Park Bench without back Sunken Foundation	Gray/Brown	Sunken Foundation	182 lbs.
8029283	71" Park Bench without back	Gray/Brown	Inground	265 lbs.
8031987	71" Park Bench without back	Gray/Brown	Surface Mount	211 lbs.

Gray frame with brown HPL

BIKE RACKS

HAGS



Our bike racks come in various designs, available as freestanding or anchored to the ground or wall. Suitable for public spaces, some models feature built-in racks, while others are complemented with additional ground or wall racks.

- Dorado: Designed to securely hold bikes, this stand reduces theft and accidental damage with individual slots for locking bikes. Can be configured to accommodate varying numbers of bikes.
- Orion: Featuring a modern and stylish design, this stand complements any urban or architectural setting with its clean lines and smooth finish. Constructed from high-quality materials, it withstands outdoor conditions and heavy use, ensuring long-lasting durability.
- Sagitta: A robust bike rack made of hot-dip galvanized steel for long durability. Its simple and sturdy arch design can be placed in a row or individually. An advantage is that the bike can be locked with the frame in the frame, increasing safety.

AVAILABLE COLORS

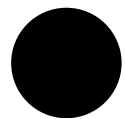

Black



Galvanized

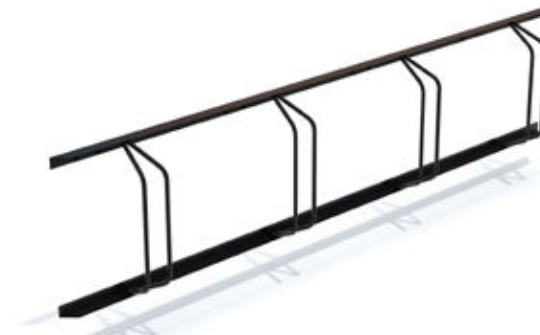

8003514

DORADO | HAGS

Model	Description	Color	Mounting	Weight
8003514	4 Bike Bicycle Rack	Black	Wall Mount	18 lbs.
8003530	4 Bike Bicycle Rack	Galvanized	Wall Mount	31 lbs.
8003533	5 Bike Bicycle Rack	Galvanized	Wall Mount	21 lbs.



8003072

ORION | HAGS

Model	Description	Color	Mounting	Weight
8003072	4 Bike Bicycle Rack	Black/Galvanized	Inground	53 lbs.
8003074	8 Bike Bicycle Rack	Black/Galvanized	Inground	67 lbs.



8003148

SAGITTA | HAGS

Model	Description	Color	Mounting	Weight
8003148	2 Bike Bicycle Rack	Galvanized	Inground	24 lbs.

TRASH RECEPTACLES

HAGS



Explore our diverse range of outdoor trash receptacles, perfect for any setting from commercial areas to public parks. These receptacles combine functionality with aesthetic appeal, improving both appearance and utility.

- Rosen: A robust 40-liter bin with a discreet high-end look. Its sloped top prevents bottles from being placed on it, and the front-opening door allows easy emptying. Suitable for general and dog waste, Rosen is available in black or galvanized finish.
- Sergel: Popular in urban environments, Sergel combines large capacity with an attractive shape. Its wide, low opening accommodates bulky waste while deterring birds. The hidden sack is easily accessed with a triangular key. Available in black or hot-dip galvanized. Design: Janne Wickelgren.

AVAILABLE COLORS

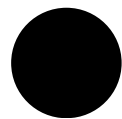

Black



Galvanized



8049776

ROSEN | HAGS

Model	Description	Color	Mounting	Weight
8049774	40 Liter Litter Bin Wall	Black	Pole Mount	43 lbs.
8059337	40 Liter Litter Bin with concrete base	Black	Surface Mount	97 lbs.
8049776	40 Liter Litter Bin Wall	Galvanized	Pole Mount	35 lbs.
8059336	40 Liter Litter Bin with concrete base	Black	Surface Mount	97 lbs.



8000109

SERGEL | HAGS

Model	Description	Color	Mounting	Weight
8000109	140 Liter Litter Bin	Black	Surface Mount	353 lbs.
8000103	140 Liter Litter Bin	Black	Sunken Foundation	221 lbs.
8000107	140 Liter Litter Bin	Galvanized	Sunken Foundation	331 lbs.
8000111	140 Liter Litter Bin	Galvanized	Surface Mount	371 lbs.

UMBRELLAS



Market

This popular style can be used in-table or freestanding in locations from outdoor dining to hotel pools.

- Two piece, 1 1/2" diameter aluminum poles
- Choice of two powder coated finishes
- Marine or furniture grade solution dyed acrylic canopies
- 1/2" flexible fiberglass ribs
- Tilt option on some models
- Three lift options—crank, push up & pin, and pulley & pin

MARKET UMBRELLA AND POLE COLORS

Standard Fabric

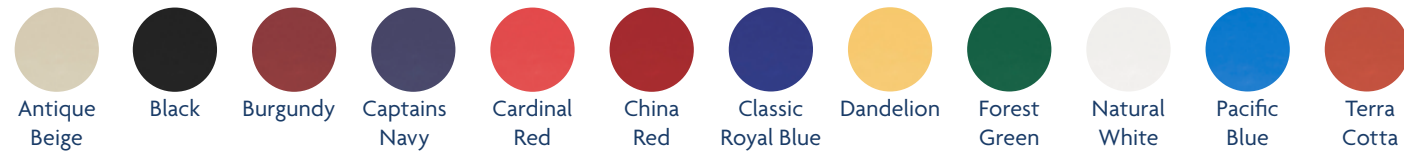

Pole Finishes



MARKET UMBRELLAS

Model	Description	Weight
UM105A	7' Market Umbrella - Crank Lift - standard fabric	19 lbs.
UM105B	7' Market Umbrella - Crank Lift - premium fabric	19 lbs.
UM106A	7' Market Umbrella - Push Up - standard fabric	19 lbs.
UM106B	7' Market Umbrella - Push Up - premium fabric	19 lbs.
UM107A	7' Market Umbrella - Pulley and Pin - standard fabric	19 lbs.
UM107B	7' Market Umbrella - Pulley and Pin - premium fabric	19 lbs.
UM110A	9' Market Umbrella - Crank Lift - standard fabric	22 lbs.
UM110B	9' Market Umbrella - Crank Lift - premium fabric	22 lbs.
UM112A	9' Market Umbrella - Pulley and Pin - standard fabric	22 lbs.
UM112B	9' Market Umbrella - Pulley and Pin - premium fabric	22 lbs.
UM115A	9' Market Umbrella - Push Up - standard fabric	28 lbs.
UM115B	9' Market Umbrella - Push Up - premium fabric	28 lbs.

Bridgewater

This contract grade umbrella features a simulated wood pole finish which has a sturdy aluminum core with a .125 wall thickness and comes in two woodgrain finishes. The 1 1/2" diameter, one piece pole allows for both in table and freestanding use.



BRIDGEWATER UMBRELLA AND POLE COLORS

Standard Fabric

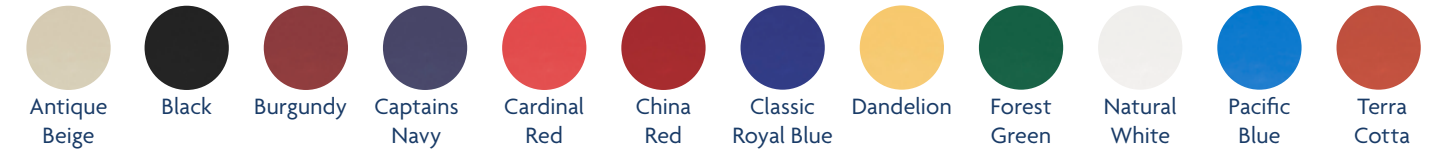

Premium Fabric



Pole Finishes



BRIDGEWATER UMBRELLAS

Model	Description	Weight
UMC532A	9' Bridgewater Faux Wood Umbrella - Push Up - standard fabric	33 lbs.
UMC532B	9' Bridgewater Faux Wood Umbrella - Push Up - premium fabric	33 lbs.

Garden

- Flexible fiberglass ribs with molded nylon joints, hubs and end tips
- Anodized and powder coated finishes
- Valance style canopy is made of vinyl coated weave
- Two piece, 1 1/2" diameter aluminum pole with .065" wall thickness



GARDEN UMBRELLA AND POLE COLORS

Fabric



Pole Finishes



GARDEN UMBRELLAS

Model	Description	Weight
UM100NA	7.5" Garden Umbrella- Crank Lift	15 lbs.

Patio

Garden umbrellas have (8) .375" ribs and a 0.065" wall thickness and come with a crank-lift mechanism.



PATIO UMBRELLA COLORS

Fabric



Pole Finishes



TERRACE UMBRELLAS

Model	Description	Weight
UMI20NA	9" Patio Umbrella- Crank Lift	17 lbs.

Aluminum

- 92" octagonal all-aluminum umbrella,
- Top canopy perforated pattern available in red ONLY
- Frame and pole available in silver ONLY
- Assembly is required



INSTALLATION

- Secured to a permanently mounted table
- Permanently surface-mounted, using the approved base if not secured to a surface-mounted or in-ground table
- If used with a third-party manufacturer's table or in a stand-alone application, the umbrella must be permanently surface-mounted to the ground
- Do not use the umbrella unless it is properly installed and mounted to a concrete surface
- Assembly instructions must be adhered to as written, or serious injuries could occur
- We strongly recommend the umbrella be used only with tables manufactured by Wabash Valley

ALUMINUM UMBRELLA COLOR

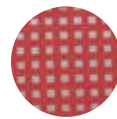

Red

ALUMINUM UMBRELLAS

Model	Description	Weight
UM130P	Aluminum Perforated Umbrella w/ Silver Pole	85 lbs.

Umbrella Bases

- All umbrellas can be used in a free-standing application as long as used in a heavy free-standing rated base. (UM310, UM315, UM320)



UMBRELLA BASES

Model	Description	Weight
UM300N	Aluminum Terrace Shell - aluminum only	4 lbs.
UM305N	Market Umbrella Stand - black only	47 lbs.
UM310	23" Aluminum Umbrella base - concrete filled - white or champagne bronze	115 lbs.
UM315	23" Aluminum Umbrella base with wheels - concrete filled - white or champagne bronze	115 lbs.
UM320	23" Aluminum Umbrella base - concrete filled - white or champagne bronze	160 lbs.



Order Information

INVOICE TERMS

Net 30 days. A finance charge of 1.5% per month or maximum allowable by law will be added to past due balance.

OPEN ACCOUNT

Credit terms are available to municipalities, government agencies, school systems and businesses (with prior approved credit). To establish credit, your organization must have a satisfactory rating with Dunn and Bradstreet. Alternatively, three credit references are required, and an order may be booked upon completion of credit investigation. To establish credit, your initial order must total at least \$500.00. Prepayment may be required for any order at Wabash Valley's sole discretion.

METHODS OF PAYMENT

MasterCard, Visa, American Express, Money order, Checks. Sorry, no C.O.D. orders.

PRICES

We strive to keep our prices as low as possible. However, due to unexpected increases, our published prices are subject to change without notice. All prices are in U.S. dollars.

SALES TAX

Will be added to the invoice, except when a tax-exempt certificate is furnished.

FREIGHT CHARGES

All freight quotes are 15% of net equipment.

To calculate freight:

- Multiply your product subtotal by .15 (15%)

If a liftgate is required for delivery on your purchase, please specify when placing your order. This will be an additional \$100 flat fee to your order. Contact our Customer Service department with any questions at 800-253-8619.

WEIGHTS

Shown as approximate and include packing materials.

CANCELLATIONS

Only accepted with approval of Wabash Valley Manufacturing.

DAMAGE/SHORTAGE CLAIMS

All claims for concealed loss or damage to product should be reported immediately to our Customer Service Department. All claims for product damage and shortage via common carrier must be promptly made by consignee (customer) direct to Wabash Valley's Customer Service Department. When reporting damage, be sure to hold all containers and packing materials for inspection (claims should be filed within 15 days of receipt of shipment).

RETURNS

No merchandise is to be returned without first obtaining written authorization from Wabash Valley Mfg., Inc. Please advise us of invoice number, invoice date and reason for your return. Any authorized merchandise must be carefully packed and in saleable condition to be accepted for return. A 25% re-stocking charge applies on all returned merchandise when error is not the fault of Wabash Valley. Please contact our customer service department for further information at 1-800-253-8619. All returned merchandise must be shipped insured, and freight prepaid.

SPECIFICATIONS/WARRANTY

Consult Wabash Valley's Sales Department or Customer Service Department for a written copy of our limited warranty and detailed specification sheets on our product line. Wabash Valley has a policy of continuous product improvement and reserves the right to discontinue or change specifications without written notice.

FREIGHT CARRIER INFORMATION

All freight is shipped unassembled via FedEx (if able) or a common carrier. On all common carrier shipments, the customer is responsible for unloading. Inside delivery is available for an additional charge.

PORTABLE BENCHES AND TABLES

All portable and free standing benches and tables must be used on level ground.

☂ Umbrella compatible

♿ Wheelchair accessible

**All wheelchair accessible tables must be adequately anchored (surface-mount adapters included)*



WABASH VALLEY



wabashvalley.com | 800-253-8619

878 HWY 60, Monett, MO 65708
2580 Esters Blvd, Suite 100 DFW Airport, TX 75261

Wabash Valley is a PlayPower, Inc. company | © 2025 Wabash Valley Manufacturing Inc. Copyright 2024 by PlayPower, Inc. | All rights reserved.

